



PLASMA TV

OWNER'S MANUAL

MODELS: RU-42PZ61/71
RU-50PZ61
RU-60PZ61

Please read this manual carefully and completely before operating your TV.

Retain this manual for future reference.

Record model number and serial number of the TV in the spaces provided below.

See the label attached on the back cover and relate this information to your dealer if you require service.

Model Number :

Serial Number :



Warning



WARNING
RISK OF ELECTRIC SHOCK
DO NOT OPEN



WARNING:
TO REDUCE THE RISK OF ELECTRIC SHOCK DO NOT REMOVE COVER (OR BACK). NO USER SERVICEABLE PARTS INSIDE. REFER TO QUALIFIED SERVICE PERSONNEL.

The lightning flash with arrowhead symbol, within an equilateral triangle, is intended to alert the user to the presence of uninsulated "dangerous voltage" within the product's enclosure that may be of sufficient magnitude to constitute a risk of electric shock to persons.

The exclamation point within an equilateral triangle is intended to alert the user to the presence of important operating and maintenance (servicing) instructions in the literature accompanying the appliance.

WARNING:

TO PREVENT FIRE OR SHOCK HAZARDS, DO NOT EXPOSE THIS PRODUCT TO RAIN OR MOISTURE.

POWER CORD POLARIZATION:
CAUTION: TO PREVENT ELECTRIC SHOCK, MATCH WIDE BLADE OF PLUG TO WIDE SLOT, FULLY INSERT.

NOTE TO CABLE/TV INSTALLER:

This reminder is provided to call the CATV system installer's attention to Article 820-40 of the National Electric Code (U.S.A.). The code provides guidelines for proper grounding and, in particular, specifies that the cable ground shall be connected to the grounding system of the building, as close to the point of the cable entry as practical.

REGULATORY INFORMATION:

This equipment has been tested and found to comply with the limits for a Class B digital device, pursuant to Part 15 of the FCC Rules. These limits are designed to provide reasonable protection against harmful interference when the equipment is operated in a residential installation. This equipment generates, uses and can radiate radio frequency energy and, if not installed and used in accordance with the instruction manual, may cause harmful interference to radio communications. However, there is no guarantee that interference will not occur in a particular installation. If this equipment does cause harmful interference to radio or television reception, which can be determined by turning the equipment off and on, the user is encouraged to try to correct the interference by one or more of the following measures:

- Reorient or relocate the receiving antenna.
- Increase the separation between the equipment and receiver.
- Connect the equipment into an outlet on a circuit different from that to which the receiver is connected.
- Consult the dealer or an experienced radio/TV technician for help.

Any changes or modifications not expressly approved by the party responsible for compliance could void the user's authority to operate the equipment.

CAUTION:

Do not attempt to modify this product in any way without written authorization from LG Electronics. Unauthorized modification could void the user's authority to operate this product.

COMPLIANCE:

The responsible party for this product's compliance is:
LG Electronics U.S.A., Inc
1000 Sylvan Avenue, Englewood Cliffs, NJ 07632
1-201-816-2000
<http://www.lgusa.com>

Safety Instructions

Important safeguards for you and your new product

Your product has been manufactured and tested with your safety in mind. However, improper use can result in electrical shock or fire hazards. To avoid defeating the safeguards that have been built into your new product, please read and observe the following safety points when installing and using your new product, and save them for future reference.

Observing the simple precautions discussed in this manual can help you get many years of enjoyment and safe operation that are built into your new product.

This product complies with all applicable U.S. Federal safety requirements, and those of the Canadian Standards Association.

1. Read Instructions

All the safety and operating instructions should be read before the product is operated.

2. Follow Instructions

All operating and use instructions should be followed.

3. Retain Instructions

The safety and operating instructions should be retained for future reference.

4. Heed Warnings

All warnings on the product and in the operating instructions should be adhered to.

5. Cleaning

Unplug this product from the wall outlet before cleaning. Do not use liquid cleaners or aerosol cleaners. Use a damp cloth for cleaning.

6. Water and Moisture

Do not use this product near water, for example, near a bath tub, wash bowl, kitchen sink, or laundry tub, in a wet basement, or near a swimming pool.

7. Accessories, Carts, and Stands

Do not place this product on a slippery or tilted surface, or on an unstable cart, stand, tripod, bracket, or table. The product may slide or fall, causing serious injury to a child or adult, and serious damage to the product. Use only with a cart, stand, tripod, bracket, or table recommended by the manufacturer, or sold with the product. Any mounting of the product should follow the manufacturer's instructions, and should use a mounting accessory recommended by the manufacturer.

8. Transporting Product

A product and cart combination should be moved with care. Quick stops, excessive force, and uneven surfaces may cause the product and cart combination to overturn.

9. Attachments

Do not use attachments not recommended by the product manufacturer as they may cause hazards.

10. Ventilation

Slots and openings in the cabinet are provided for ventilation and to ensure reliable operation of the product and to protect it from overheating, and these openings must not be blocked or covered. The openings should never be blocked by placing the product on a bed, sofa, rug, or other similar surface. This product should not be placed in a built-in installation such as a bookcase or rack unless proper ventilation is provided or the manufacturer's instructions have been adhered to.

11. Power Sources

This product should be operated only from the type of power source indicated on the marking label. If you are not sure of the type of power supply to your home, consult your product dealer or local power company. For products intended to operate from battery power, or other sources, refer to the operating instructions.

12. Power-Cord Polarization

This product is equipped with a three-wire grounding type plug, a plug having a third (grounding) pin. This plug will only fit into the grounding-type power outlet. This is a safety feature. If you are unable to insert the plug into the outlet, contact your electrician to replace your obsolete outlet. Do not defeat the safety purpose of the grounding-type plug.

13. Power-Cord Protection

Power-supply cords should be routed so that they are not likely to be walked on or pinched by items placed upon or against them, paying particular attention to cords at plugs, convenience receptacles, and the point where they exit from the product.



PORTABLE CART WARNING

Safety Instructions continued

14. Outdoor Antenna Grounding

If an outside antenna or cable system is connected to the product, be sure the antenna or cable system is grounded so as to provide some protection against voltage surges and built-up static charges. Article 810 of the National Electrical Code (U.S.A.), ANSI/ NFPA 70 provides information with regard to proper grounding of the mast and supporting structure, grounding of the lead-in wire to an antenna discharge unit, size of grounding conductors, location of antenna-discharge unit, connection to grounding electrodes, and requirements for the grounding electrode.

Example of Grounding According to National Electrical Code Instructions

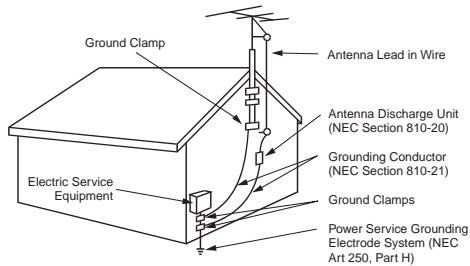

NEC - National Electrical Code

15. Lightning

For added protection for this product (receiver) during a lightning storm, or when it is left unattended and unused for long periods of time, unplug it from the wall outlet and disconnect the antenna or cable system. This will prevent damage to the product due to lightning and power-line surges.

16. Power Lines

An outside antenna system should not be located in the vicinity of overhead power lines or other electric light or power circuits, or where it can fall into such power lines or circuits. When installing an outside antenna system, extreme care should be taken to keep from touching such power lines or circuits as contact with them might be fatal.

17. Overloading

Do not overload wall outlets and extension cords as this can result in a risk of fire or electric shock.

18. Object and Liquid Entry

Never push objects of any kind into this product through openings as they may touch dangerous voltage points or short-out parts that could result in a fire or electric shock. Never spill liquid of any kind on the product.

19. Servicing

Do not attempt to service this product yourself as opening or removing covers may expose you to dangerous voltage or other hazards. Refer all servicing to qualified service personnel.

20. Damage Requiring Service

Unplug this product from the wall outlet and refer servicing to qualified service personnel under the following conditions:

- If the power-supply cord or plug is damaged.
- If liquid has been spilled, or objects have fallen into the product.
- If the product has been exposed to rain or water.
- If the product does not operate normally by following the operating instructions. Adjust only those controls that are covered by the operating instructions as an improper adjustment of other controls may result in damage and will often require extensive work by a qualified technician to restore the product to its normal operation.
- If the product has been dropped or the cabinet has been damaged.
- If the product exhibits a distinct change in performance.

21. Replacement Parts

When replacement parts are required, be sure the service technician has used replacement parts specified by the manufacturer or have the same characteristics as the original part. Unauthorized substitutions may result in fire, electric shock, or other hazards.

22. Safety Check

Upon completion of any service or repairs to this product, ask the service technician to perform safety checks to determine that the product is in proper operating condition.

23. Wall or Ceiling Mounting

The product should be mounted to a wall or ceiling only as recommended by the manufacturer. The product may slide or fall, causing serious injury to a child or adult, and serious damage to the product.

24. Heat

The product should be situated away from heat sources such as radiators, heat registers, stoves, or other products (including amplifiers) that produce heat.

Contents

Warnings	2	Auto Clock Setup	25
Safety Instructions	3~4	Manual Clock Setup	25
Introduction		On/Off Timer Setup	25
Controls	7	Sleep Timer / Auto Off	26
Connection Options	8	Special Menu Options	
Remote Control Key Functions	9	Key Lock	27
Installation		ISM (Image Sticking Minimization) Method	27
Installation Instruction	10	Low Power	28
Joining the TV assembly to the wall to protect the set tumbling	11	XD Demo	28
Speakers mounted on the monitor	11	Closed Captions	29
Mounting speakers on TV	11	Captions	29
Connecting Speakers to the Monitor using		Caption/Text	29
the speaker wires provided	11	Screen Menu Options	
Install the RING SPACER with the bolts on the set		Auto Adjustment	30
as shown. (Only RU-60PZ61 series)	12	Setting Picture Format	30
External Equipment Connections	12	Screen Position	30
Antenna Connection	12	Manual Configure	31
VCR Setup / Cable TV Setup	13	Setting VGA Mode	31
External A/V Source Setup	14	Setting XGA Mode	31
DVD Setup	14	Screen Adjustments	32
DTV Setup / Monitor Out Setup	15	Cinema Mode Setup	32
PC Setup	16-17	Luminance Noise Reduction	32
Initializing (Reset to original factory value)	33	Split Zoom	33
Operation		Lock Menu Options	
Turning the TV On	18	Parental Lock Setup	34
Menu Language Selection	18	PIP (Picture-In-Picture)/Double Window Feature	
Channel Menu Options		Watching PIP/Double Window	35
Auto Program: Channel Search	19	Swapping the PIP/Double Window	35
Manual Program: Adding/Deleting Channels	19	TV Program selection for PIP	35
Fine Tuning Adjustment	19	Selecting an Input Signal Source for PIP/Double Window	35
Signal Reception Booster	20	Moving the PIP	35
Favorite Channels Setup	20	PIP Size	35
Picture Menu Options		PIP Transparency	35
APC (Auto Picture Control)	21	External Control Device Setup	36~41
XD	21	IR Codes	42~43
Color Temperature Control	21	Programming the Remote	44
Flesh tone	22	Programming Codes	45~46
sRGB	22	Troubleshooting Checklist	47
Manual Picture Control (APC set to Off option)	22	Maintenance	48
Sound Menu Options		Product Specifications	49
DASP (Digital Auto Sound Processing)	23	Warranty	51~52
BBE	23		
AVL (Auto Volume Leveler)	23		
Manual Sound Control (DASP off option and balance)	24		
Stereo/SAP Broadcasts Setup	24		
Timer Menu Options			

Setup and Operation Checklist

Setup and Operation Checklist

(See pages 12~16 for available connection and operational setup options.)

1. Unpack TV and all accessories.
2. Connect all external video and audio equipment.
see pages 14 ~ 16.
3. Install batteries in remote control.
See page 9.
4. Turn TV on.
See page 18.
5. Turn video source equipment on.
6. Select viewing source for TV.
See page 21~22.
7. Fine-tune source image and sound to your personal preference or as required by source.
See pages 21 ~ 24.
8. Additional features set up
See Contents above.

Introduction

What is a Plasma Display Panel (PDP)?

A plasma display panel is the latest display technology. It is currently the best way to achieve flat panel displays with excellent image quality and large screen sizes, that are easily viewable. The PDP can be thought of as a descendant of the neon lamp and it can be also be viewed as a series of fluorescent lamps.

How does it work?

PDP is an array of cells, known as pixels, which are comprised of 3 sub pixels, corresponding to the colors red, green, and blue. Gas in a plasma state is used to react with phosphors in each sub-pixel to produce colored light (red, green, or blue). These phosphors are the same types used in Cathode Ray Tube (CRT) devices such as televisions and common computer monitors.

You get the rich, dynamic colors that you expect. Each sub-pixel is individually controlled by advanced electronics to produce over 16 million different colors. All of this means that you get perfect images that are easily viewable in a display that is less than 5 inches thick.

160° - Wide angle range of vision

Your flat panel plasma screen offers an exceptionally broad viewing angle -- over 160 degrees. This means that the display is clear and visible to viewers anywhere in the room who can see the screen.

Wide Screen

The screen of the Plasma Display is so wide that your viewing experience is as if you are in a theater.

Multimedia

Connect your plasma display to a PC and you can use it for conferencing, games, and Internet browsing. The Picture-in-Picture feature allows you to view your PC and video images simultaneously.

Versatile

The light weight and thin size makes it easy to install your plasma display in a variety of locations where conventional TVs will not fit.

The PDP Manufacturing Process: a few minute colored dots may be present on the PDP screen

The PDP (Plasma Display Panel), which is the display device of this product is composed of 0.9 to 2.2 million cells. A few cell defects will normally occur in the PDP manufacturing process. Several tiny, minute colored dots visible on the screen should be acceptable. This also occurs in other PDP manufacturers' products. The tiny dots appearing does not mean that this PDP is defective. Thus a few cell defects are not sufficient cause for the PDP to be exchanged or returned. Our production technology minimizes these cell defects during the manufacture and operation of this product.

In the same way that a fan is used in a PC computer to keep the CPU (Central Processing Unit) cool, the PDP is equipped with cooling fans to cool the Monitor and improve its reliability. Therefore, a certain level of noise could occur while the fans are operating and cooling the PDP.

The fan noise doesn't have any negative effect on the PDP's efficiency or reliability. The noise from these fans is normal during the operation of this product. We hope you understand that a certain level of noise from the cooling fans is acceptable and is not sufficient cause for the PDP to be exchanged or returned.

Controls

- This is a simplified representation of front panel.
Here shown may be somewhat different from your TV.

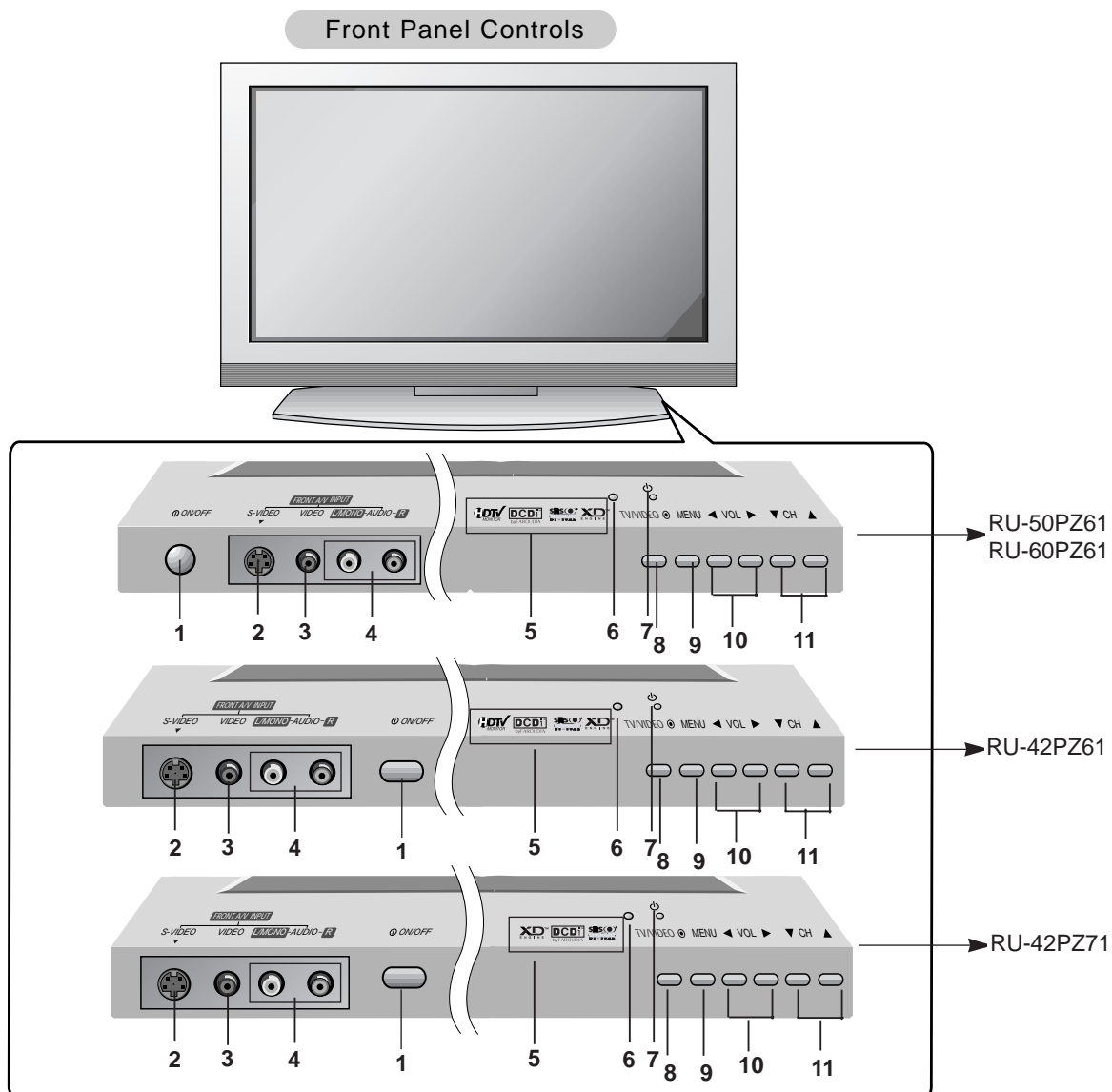

1. ON/OFF Button

2. S-VIDEO Input

A connection available to provide better picture quality than the video input.

3. VIDEO Input

Connects the video signal from a video device.

4. AUDIO Input

Use to connect to hear stereo sound from an external device.

5. INDEX

Switches LED Display on or off.

6. Remote Control Sensor

7. Power Standby Indicator

Illuminates red in standby mode, Illuminates green when the TV is turned on.

8. TV/VIDEO or ENTER Button

9. MENU Button

10. VOLUME (F, G) Buttons

11. CHANNEL (E, D) Buttons

Connection Options

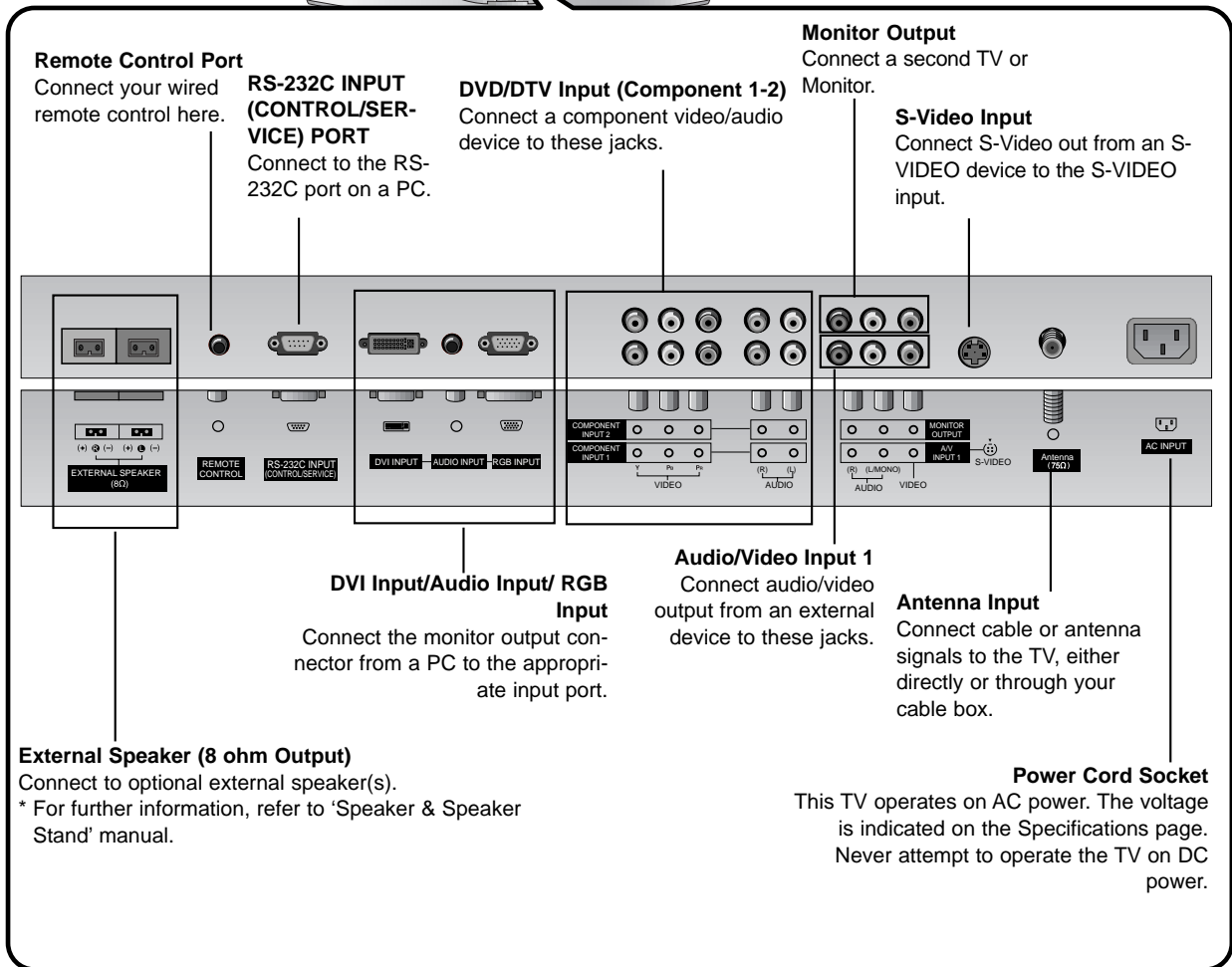
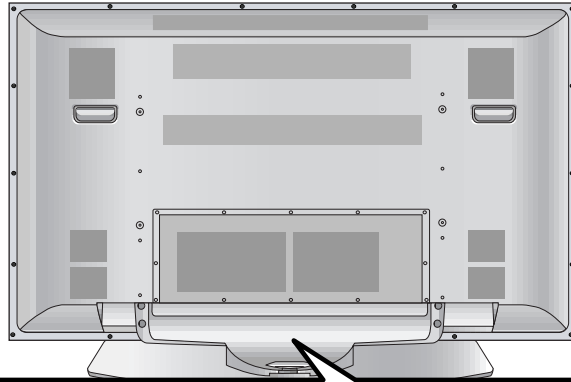

Remote Control Key Functions

- When using the remote control, aim it at the remote control sensor on the TV.

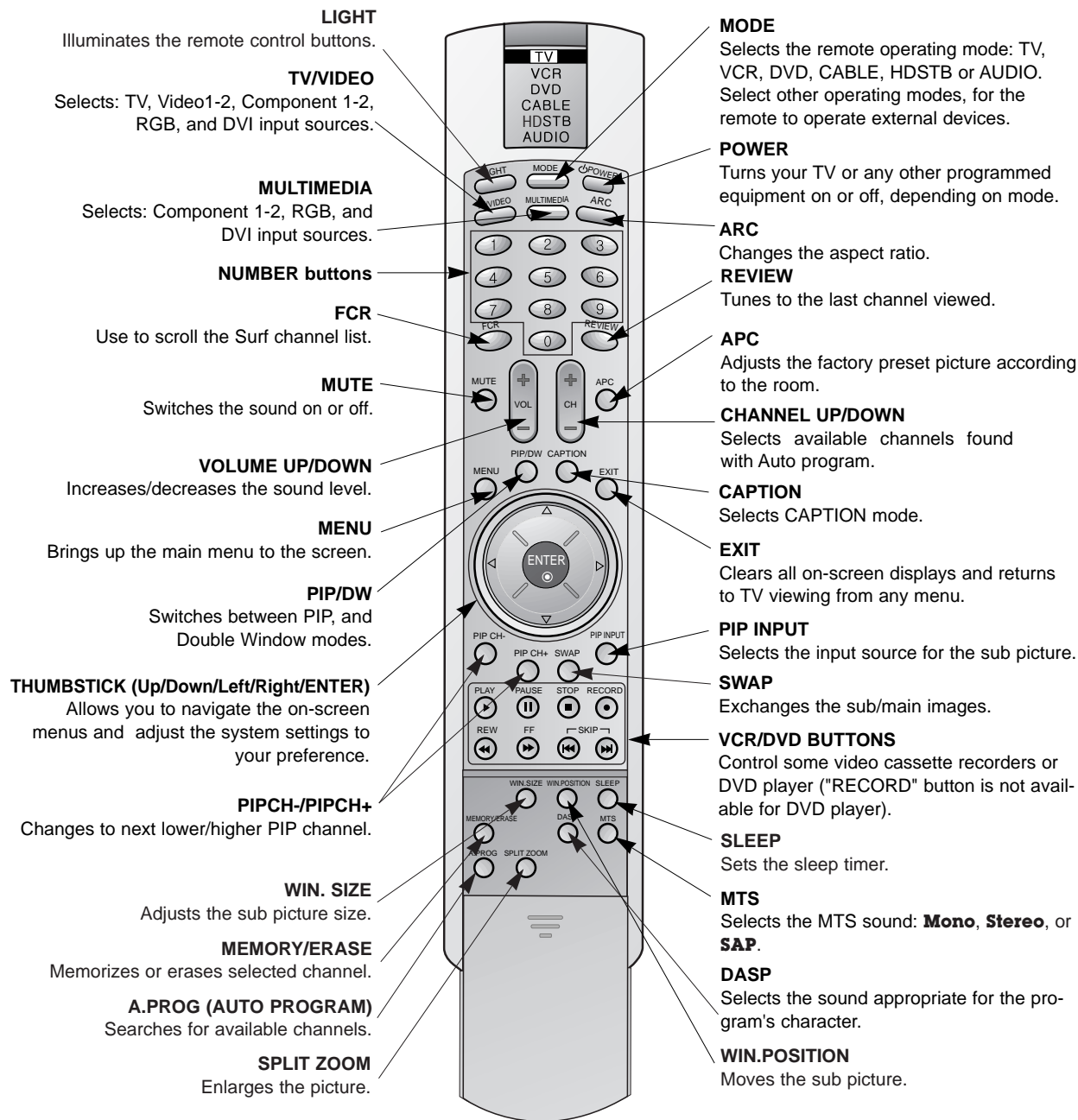

Installing Batteries

- Open the battery compartment cover on the back side and install the batteries matching correct polarity (+ with +, - with -).
- Install two 1.5V AA batteries. Don't mix old or used batteries with new ones. Replace cover.



Installation

Ensure that the following accessories are included with your plasma display. If an accessory is missing, please contact the dealer where you purchased the product.

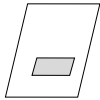

Owner's Manual

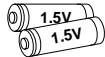

Batteries

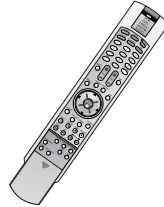

Remote Control



Power Cord



2-TV bracket bolts
(Only RU-42PZ61/71, 50PZ61 series)



4- Bolts
(Attach Supporter
Hanger to monitor-4)
(Only RU-42PZ61/71, 50PZ61 series)



6-RING SPACER
(Only RU-60PZ61 series)



6-Wall mounting bracket bolts
(Only RU-60PZ61 series)



75Ω Round Cable



2-TV brackets
2-Wall brackets
(Only RU-42PZ61/71,50PZ61 series)



2-Speaker Wires
(Only RU-42PZ61/71,50PZ61 series)

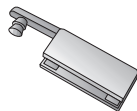

Cover Cable
(Only RU-42PZ61/71,50PZ61 series)



2-Speaker Wire Holders
(for arranging the speaker wires.)
(Only RU-42PZ61/71, 50PZ61 series)

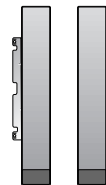

2-Speaker+2-supporter hanger
(Only RU-42PZ61/71,50PZ61 series)

Installation Instructions

GROUNDING

Ensure that you connect the grounding / earth wire to prevent possible electric shock. If grounding methods are not possible, have a qualified electrician install a separate circuit breaker. Do not try to ground the unit by connecting it to telephone wires, lightening rods, or gas pipes.

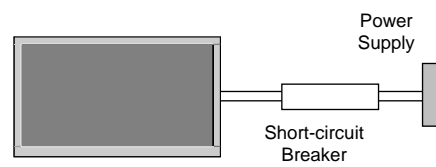

Joining the TV assembly to the wall to protect the set tumbling

- Secure the TV assembly by joining it to a wall by using the TV/Wall brackets.
- RU-60PZ61 series TV's stand is saled, separately .
- Here shown may be somewhat different from your TV.

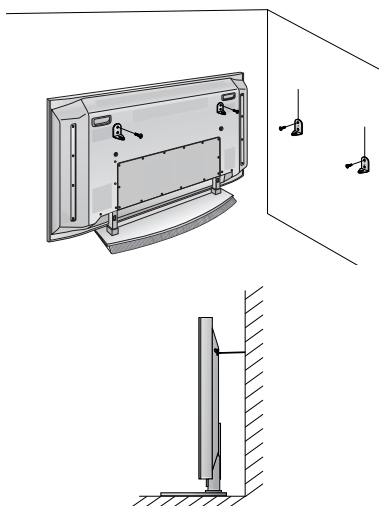

- After the set must be mounted on the desk top, install the TV brackets on the TV as shown. Install the TV brackets on the TV as shown. Insert the 2 bolts and tighten securely, in the upper holes on the bracket. Install the wall brackets on the wall with 4 bolts*, (not supplied with the product), as shown. Match the height of the TV brackets and the wall brackets. Check to be sure the brackets are tightened securely.
- Secure the TV assembly to the wall with strong strings or wound wire cables, (not supplied with the product), as shown.

Speakers mounted on the monitor

- RU-60PZ61 series TV's speaker is saled, separately .
- Here shown may be somewhat different from your TV.

• Mounting speakers on TV

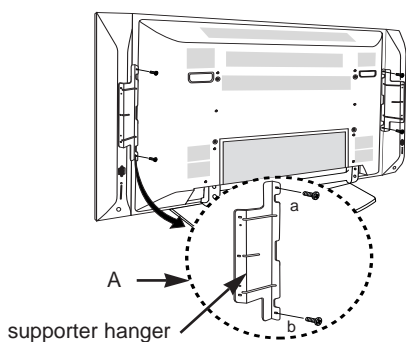

Assemble the monitor to speaker with using the supporter hanger and bolt. As shown above A, Assemble the a, b to the TV with using the bolt. If the bolts are tightened too much, the product could be damaged.
Caution: Always lift the TV itself (not the speakers) when handling or moving the monitor after speakers have been installed.

• Connecting Speakers to the Monitor using the speaker wires provided.

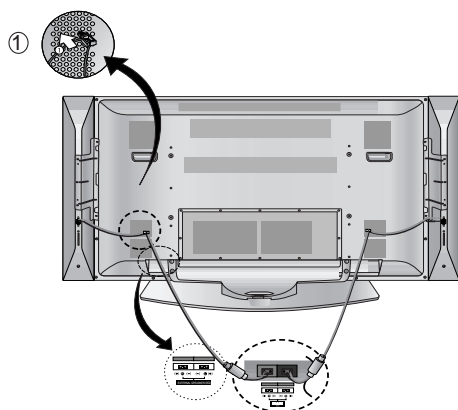

Place the speakers in the position you want. Install the speaker wires on the TV and speaker. Be sure to connect the positive "+" wire to the "+" input and the negative "-" wire to the "-" input. Connect left monitor input to left speaker and right monitor input to right speaker. Any extra speaker wire length remaining can be bunched into the wire holders provided, see ① above to install wire holders. (Caution: Once installed, the speaker wire holders lock into position and can't be removed.)
Caution: Be sure TV power is turned off before making any connections.

• **Install the RING SPACER with the bolts on the set as shown.** (Only RU-60PZ61 series)

1. Put the RING SPACER in the holes of the bolts before connecting to the wall mounting bracket.
2. When you connect the wall mounting bracket to the set, connect to it by using the bolts, (supplied with the product), as shown.

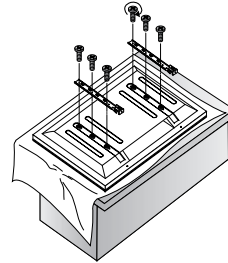
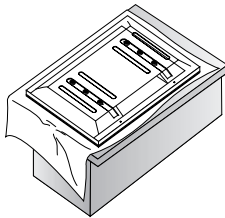

External Equipment Connections

Antenna Connection

- Antenna or Cable Service without a Cable Box Connections
- For optimum picture quality, adjust antenna direction if needed.

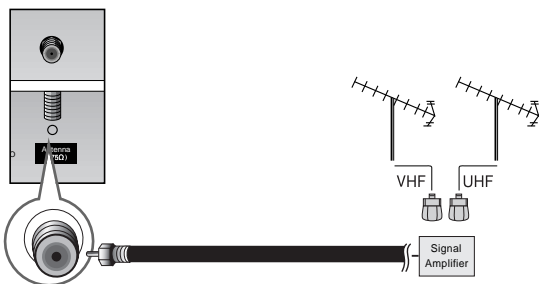
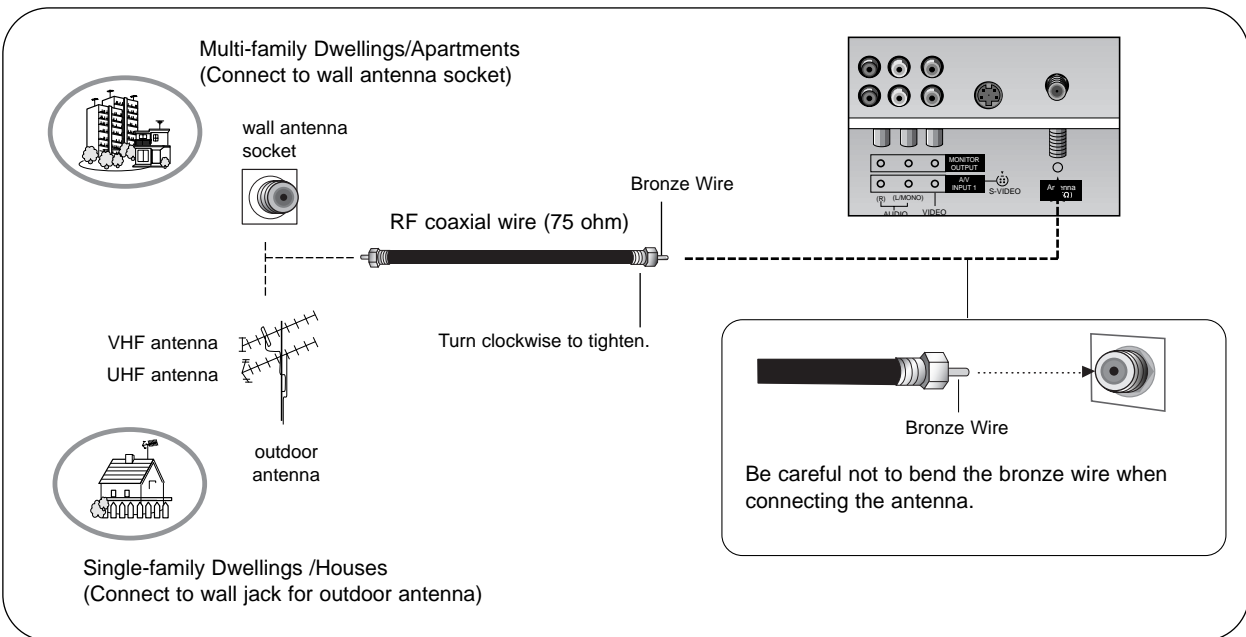

- To improve picture quality in a poor signal area, purchase and install a signal amplifier.
- If the antenna needs to be split for two TV's, install a "2-Way Signal Splitter" in the connections.
- If the antenna is not installed properly, contact your dealer for assistance.

NOTE: All cables shown are not included with the TV

VCR Setup

- To avoid picture noise (interference), leave an adequate distance between the VCR and TV
- Use the ISM Method (on the Option menu) feature to avoid having a fixed image remain on the screen for a long period of time. Typically a frozen still picture from a VCR. If the 4:3 picture format is used; the fixed images on the sides of the screen may remain visible on the screen.

Connection Option 1

Set VCR output switch to 3 or 4 and then tune TV to the same channel number.

Connection Option 2

1. Connect the audio and video cables from the VCR's output jacks to the TV input jacks, as shown in the figure.
When connecting the TV to VCR, match the jack colors (Video = yellow, Audio Left = white, and Audio Right = red).
If you connect an S-VIDEO output from VCR to the S-VIDEO input, the picture quality is improved; compared to connecting a regular VCR to the Video input.
2. Insert a video tape into the VCR and press PLAY on the VCR. (Refer to the VCR owner's manual.)
3. Select the input source by the **TV/VIDEO** button on the remote control. (If connected to A/V INPUT 1, select **Video 1** input source)

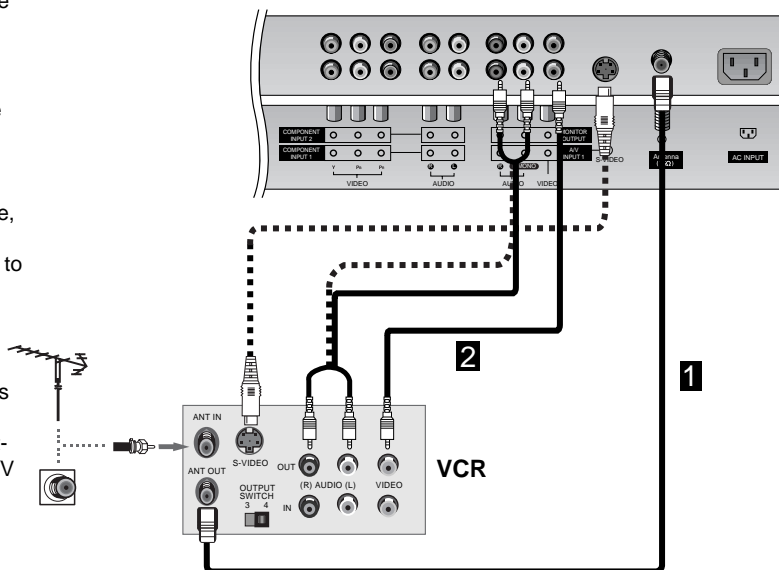

Do not connect to both Video and S-Video at the same time. In the event that you connect both Video and the S-Video cables, only the S-Video will work.)

Cable TV Setup

- After subscribing to a cable TV service from a local provider you can watch cable TV programming. The TV cannot display TV programming unless a TV tuner device or cable TV converter box is connected to the TV.
- For further information regarding cable TV service, contact your local cable TV service provider(s).

Connection Option 1

1. Select 3 or 4 with channel switch on cable box.
2. Tune the TV channel to the same selected output channel on cable box.
3. Select channels at the cable box or with the cable box remote control.

Connection Option 2

1. Connect the audio and video cables from the Cable Box's output jacks to the TV input jacks, as shown in the figure.
When connecting the TV to a Cable Box, match the jack colors (Video = yellow, Audio Left = white, and Audio Right = red).
2. Select the input source by using the **TV/VIDEO** button on the remote control. (If connected to A/V INPUT 1, select **Video 1** input source)
3. Select your desired channel with the remote control for cable box.

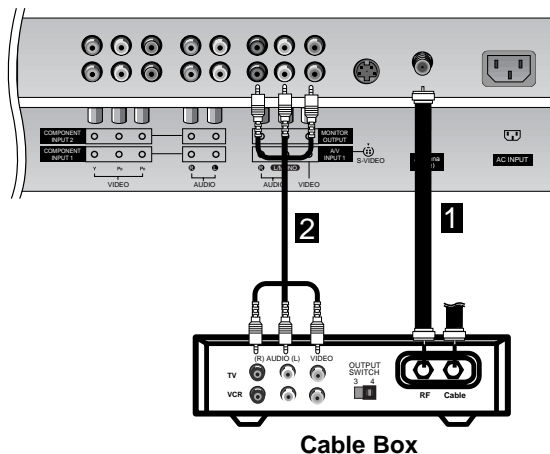

External A/V Source Setup

How to connect

Connect the audio and video cables from the external equipment's output jacks to the TV input jacks, as shown in the figure.

When connecting the TV to external equipment, match the jack colors (Video = yellow, Audio Left = white, and Audio Right = red).

How to use

1. Select the input source by using the **TV/VIDEO** button on the remote control. (If connected to A/V INPUT 1, select **Video 1** input source).
2. Operate the corresponding external equipment. Refer to external equipment operating guide.

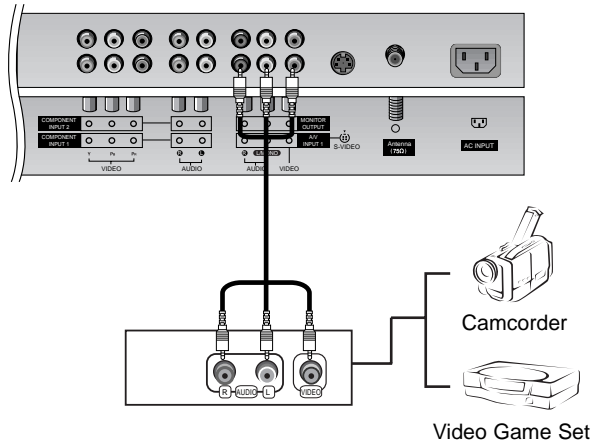

DVD Setup

How to connect

1. Connect the DVD video outputs (Y, Pb, Pr) to the COMPONENT (Y, Pb, Pr) INPUT jacks on the TV and connect the DVD audio outputs to the AUDIO INPUT jacks on the TV, as shown in the figure.
2. If your DVD only has an S-Video output jack, connect this to the S-VIDEO input on the TV and connect the DVD audio outputs to the AUDIO INPUT jacks on the TV, as shown in the figure.

NOTE: If your DVD player does not have component video output, use S-Video.

How to use

1. Turn on the DVD player, insert a DVD.
2. Use the **TV/VIDEO** or **MULTIMEDIA** button on the remote control to select **Component 1** or **Component 2**. (If connected to S-VIDEO, select the **Video 1** or **Video 2** external input source.)
3. Refer to the DVD player's manual for operating instructions.

• **Component Input ports**

To get better picture quality, connect a DVD player to the component input ports as shown below.

Component ports on the TV	Y	Pb	Pr
Video output ports on DVD player	Y	Pb	Pr
	Y	B-Y	R-Y
	Y	Cb	Cr
	Y	PB	PR

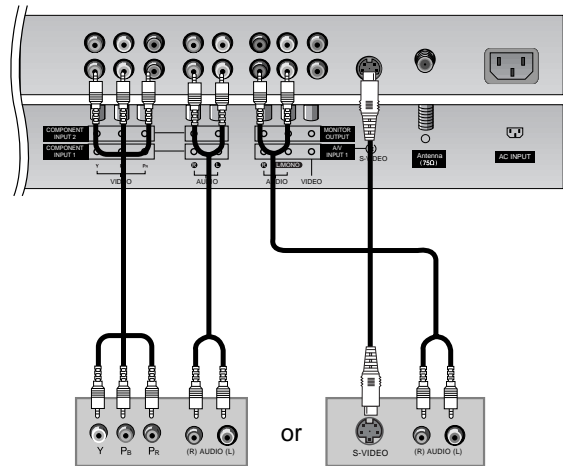

DVD

DTV Setup

- To watch digitally broadcast programs, purchase and connect a digital set-top box.

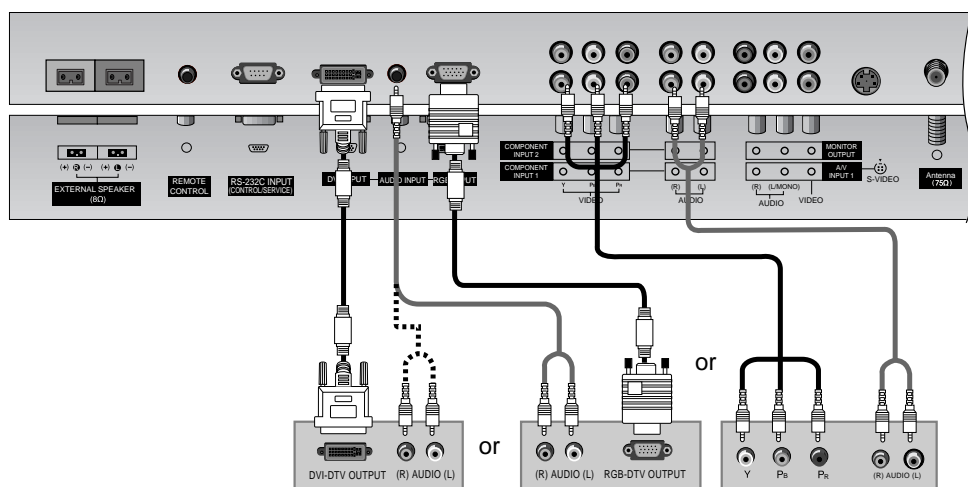

Digital Set-top Box

How to connect

Use the TV's COMPONENT (Y, Pb, Pr) INPUT jacks, RGB or DVI port for video connections, depending on your set-top box connections available. Then, make the corresponding audio connections.

How to use

1. Turn on the digital set-top box. (Refer to the owner's manual for the digital set-top box.)
2. Use **TV/VIDEO** or **MULTIMEDIA** on the remote control to select **Component 1**, **Component 2**, **RGB**, or **DVI** source.

Signal	Component 1/2	RGB,DVI
480i	Yes	No
480p	Yes	Yes
720p	Yes	Yes
1080i	Yes	Yes

Monitor Out Setup

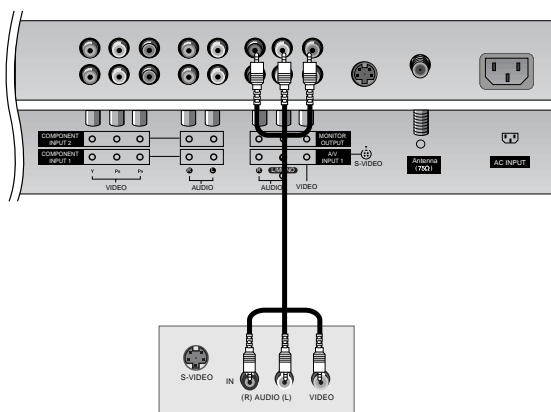

The TV has a special signal output capability which allows you to hook up a second TV or monitor.

Connect the second TV or monitor to the TV's MONITOR OUTPUT. See the Operating Manual of the second TV or monitor for further details regarding that device's input settings.

NOTE

- Component, RGB, DVI input sources cannot be used for Monitor out.

PC Setup

How to connect

1. To get the best picture quality, adjust the PC graphics card to (RU-42PZ61->1024x768, RU-42PZ71->852x480, RU-50/60PZ61->1366x768), 60Hz.
2. Use the TV's RGB INPUT or DVI (Digital Visual Interface) INPUT port for video connections, depending on your PC connector.
 - If the graphic card on the PC does not output analog and digital RGB simultaneously, connect only one of either RGB INPUT or DVI INPUT to display the PC on the TV.
 - If the graphic card on the PC does output analog and digital RGB simultaneously, set the TV to either RGB or DVI; (the other mode is set to Plug and Play automatically by the TV.)
3. Then, make the corresponding audio connection. If using a sound card, adjust the PC sound as required.

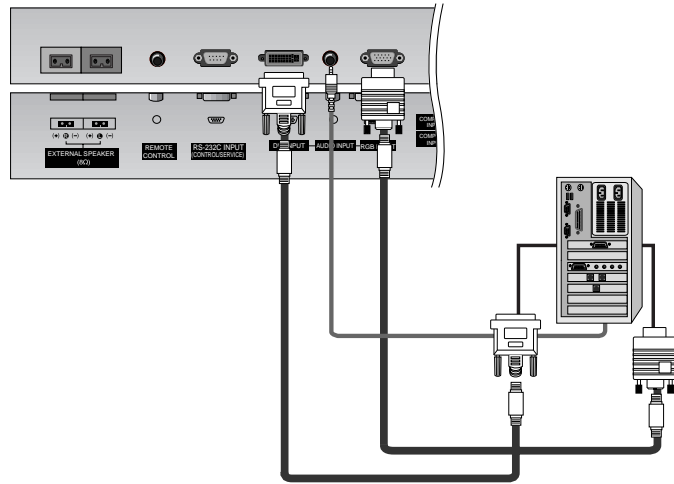

How to use

1. Turn on the PC and the TV.
2. Turn on the display by pressing the POWER button on the TV's remote control.
3. Use **TV/VIDEO** or **MULTIMEDIA** on the remote control to select **RGB**, or **DVI** source.
4. Check the image on your TV. There may be noise associated with the resolution, vertical pattern, contrast or brightness in PC mode. If noise is present, change the PC mode to another resolution, change the refresh rate to another rate or adjust the brightness and contrast on the menu until the picture is clear. If the refresh rate of the PC graphic card can not be changed, change the PC graphic card or consult the manufacturer of the PC graphic card.

NOTES:

- Use a DVI cable.
- Avoid keeping a fixed image on the TV's screen for a long period of time. The fixed image may become permanently imprinted on the screen. Use the Orbiter screen saver when possible.
- The synchronization input form for Horizontal and Vertical frequencies is separate.

Displayable Monitor Specifications

RGB / DVI Mode

Resolution	Horizontal Frequency(KHz)	Vertical Frequency(Hz)
640x350	31.468	70.09
	37.861	85.08
720x400	31.469	70.08
	37.927	85.03
640x480	31.469	59.94
	35.000	66.66
	37.861	72.80
	37.500	75.00
848x480	43.269	85.00
	31.500	60.00
848x480	37.799	70.00
	39.375	75.00
	31.500	60.00
852x480	37.799	70.00
	39.375	75.00
	31.500	60.00
800x600	35.156	56.25
	37.879	60.31
	48.077	72.18
	46.875	75.00
	53.674	85.06
832x624	49.725	74.55
1024x768	48.363	60.00
	56.476	70.06
	60.023	75.02
	68.677	85.00
1360x768 (XGA)	47.700	60.00
	59.625	75.02
1366x768 (XGA)	47.700	60.00
	59.625	75.02
1152x864 (RGB)	54.348	60.05
	63.995	70.01
	67.500	75.00
1152x864 (RGB)	77.487	85.00
1152x870(RGB)	68.681	75.06
1280x768 (XGA)	47.693	59.922
	60.0911	74.926
	68.504	84.887
1280x960(RGB)	60.023	60.02
1280x1024(RGB)	63.981	60.02

RU-42PZ61/71

RGB / DVI Mode

Resolution	Horizontal Frequency(KHz)	Vertical Frequency(Hz)
640x350	31.468	70.09
	37.861	85.08
720x400	31.469	70.08
	37.927	85.03
640x480	31.469	59.94
	35.000	66.66
	37.861	72.80
	37.500	75.00
848x480	43.269	85.00
	31.500	60.00
848x480	37.799	70.00
	39.375	75.00
	31.500	60.00
852x480	37.799	70.00
	39.375	75.00
	31.500	60.00
800x600	35.156	56.25(RGB)
	37.879	60.31
	48.077	72.18
	46.875	75.00
	53.674	85.06
832x624	49.725	74.55
1024x768	48.363	60.00
	56.476	70.06
	60.023	75.02
	68.677	85.00
1360x768	47.700	60.00
	59.625	75.02
1366x768	68.500	85.00
	47.700	60.00
1366x768	59.625	75.02
	69.500	85.00
	54.348	60.05
1152x864 (RGB)	63.995	70.01
	67.500	75.00
	77.487	85.00
	68.681	75.06
1152x870(RGB)	68.681	75.06
1280x768	47.693	59.922
	60.0911	74.926
	68.504	84.887
1280x960(RGB)	60.023	60.02
1280x1024(RGB)	63.981	60.02

RU-50/60PZ61

Operation

Turning the TV On

* In this manual, the OSD (On Screen Display) may be different from your TV's because it is just an example to help you with the TV operation.

Turning on the TV just after installation

1. Connect power cord correctly.
2. Press the **⓪ ON/OFF** button on the TV. At this moment, the TV is switched to standby mode. Press the **TV/VIDEO, CH (D / E)** button on the TV or press the **POWER, TV/VIDEO, MULTIMEDIA, Number (0 ~ 9)** button on the remote control and then the TV will turn on.

Turning on the TV (power cord is still connected)

1. If the TV was turned off with the **⓪ ON/OFF** button on the TV
 - Press the **⓪ ON/OFF** button on the TV to turn the TV on.
2. If the TV was turned off with the remote control and then the **⓪ ON/OFF** button on the TV
 - Press the **⓪ ON/OFF** button on the TV and then press the **TV/VIDEO, CH (D / E)** button on the TV or press the **POWER, TV/VIDEO, MULTIMEDIA, Number (0 ~ 9)** button on the remote control to turn the TV on.

NOTE

- If you intend to be away on vacation, disconnect the power plug from the wall power outlet.

Menu Language Selection

- The menus can be shown on the screen in the selected language. First select your language.

1. Press the **MENU** button and then use **D / E** button to select the **SPECIAL** menu.
2. Press the **G** button and then use **D / E** button to select **Language**.
3. Press the **G** button and then use **D / E** button to select your desired language.
From this point on, the on-screen menus will be shown in the language of your choice.
4. Press the **ENTER** button to save.

Channel Menu Options

Auto Program should be used to memorize all the active channels in your area before you are able to use the TV.

There are two ways of storing channels in the TV's memory. You can use either.

One is called AUTO PROGRAM and the other is called MANUAL PROGRAM.

In AUTO PROGRAM mode, the TV will memorize the channels in ascending numerical order. If there are additional channels you want to add or delete, you can manually add or delete those channels with Manual Program.

Auto Program: Channel Search

- Redo Auto Program if the Plasma Display is ever moved to another location.
- Auto Program will search for channels only through the ANT IN jack.
- If channels numbers for broadcast over-the air TV and cable TV are duplicated where different channels have the same number, press the same number buttons again to toggle between:

Broadcast TV Channels



Cable TV Channels

(For example, press 17 to go to the channel, press 17 again to go to the duplicated channel.)

1. Press the **A.PROG** button and then press the **G** button. AUTO PROGRAM starts the channel search. If you want to stop auto programming, press the **ENTER** button. Only the channels found up to that time are memorized.
 - You can also select the **Auto program** option and do a channel search in the **CHANNEL** menu.



Manual Program: Adding/Deleting Channels

- You can add or delete channels from the channel scan manually.
1. Use the **D / E** or **NUMBER** buttons to select the channel number you want to add or delete.
 2. Press the **MEMORY/ERASE** button.
 3. Use the **MEMORY/ERASE** button to select **Memory** or **Erase**.
 4. Press the **ENTER** button.
 - You can also do **Manual program** with the **CHANNEL** menu.

Fine Tuning Adjustment

- Use this function to correct the picture's instability and condition if it is poor.
1. Press the **MENU** button and then use **D / E** button to select the **CHANNEL** menu.
 2. Press the **G** button and then use **D / E** button to select **Manual program**.
 3. Press the **G** button and then use **D / E** button to select **Fine**.
 4. Use the **F / G** button to adjust the picture to your preference.
 5. Press the **ENTER** button to save.

Notes

- To remove fine tuning from a channel, reprogram the finely-tuned channel with Auto program or Manual Program.
- If a finely-tuned channel is memorized, the color of the channel number changes to yellow.

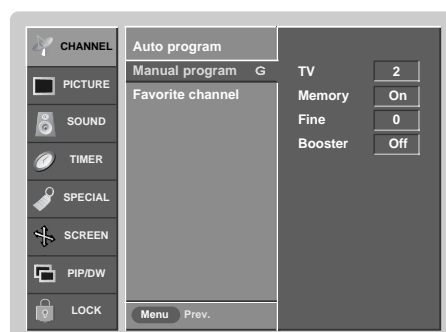

Channel Menu Options continued

Signal Reception Booster

- If TV signal reception is poor because you are in a fringe area, set Booster to On. If the picture condition is good, set Booster to Off.
- Adjustments for one channel don't affect the adjustment for other channels. Set booster to on or off for each channel separately.

1. Press the **MENU** button and then use **D / E** button to select the **CHANNEL** menu.
2. Press the **G** button and then use **D / E** button to select **Manual program**.
3. Press the **G** button and then use **D / E** button to select **Booster**.
4. Use **F / G** button to select **On** or **Off**.
5. Press the **ENTER** button to save.



Favorite Channels Setup

- Favorite Channels is a convenient feature that lets you quickly scan up to 8 channels of your choice without having to wait for the TV to scan through all the in-between channels.

1. Press the **MENU** button and then use **D / E** button to select the **CHANNEL** menu.
2. Press the **G** button and then use **D / E** button to select **Favorite channel**.
3. Press the **G** button and then use **D / E** button to select the first favorite channel position.
4. Use the **F / G** button to set the desired channel number for first favorite channel.
5. Repeat steps 3 to 4 to memorize other favorite channels.
6. Press the **ENTER** button to save.

- To tune to a favorite channel, press the **FCR** (Favorite Channel Review) button repeatedly. The eight favorite channels appear on the screen in numerical order.

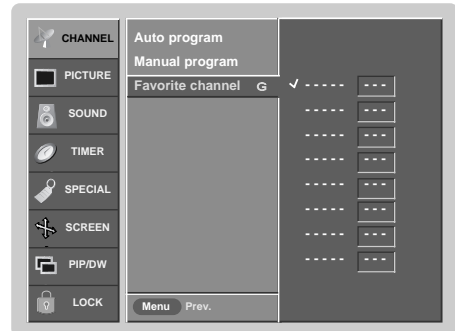

Picture Menu Options

APC (Auto Picture Control)

- APC adjusts the TV to the best picture appearance.
- If adjusting picture options (contrast, brightness, color, sharpness, or tint) manually, APC automatically changes to **Off**.

1. Press the **APC** button repeatedly to select the picture appearance setup option as shown below.



- You can also adjust **APC** in the **PICTURE** menu.
- **Daylight**, **Optimum**, and **Night time** settings are preset for good picture quality at the factory and cannot be changed.

XD

- XD is LG Electronic's unique picture improving technology to display a real HD source through an advanced digital signal processing algorithm.
- When selecting APC options (Clear, Optimum and Soft), XD is automatically change to On.

1. Press the **MENU** button and then use **D / E** button to select the **PICTURE** menu.
2. Press the **G** button and then use **D / E** button to select **XD**.
3. Press the **G** button and then use **D / E** button to set **On** or **Off**.
4. Press the **ENTER** button to save.

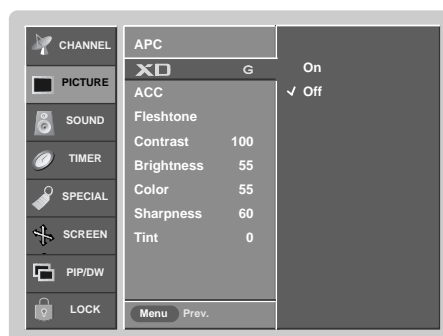

Color Temperature Control

Auto Color Temperature Control

- To initialize values (reset to default settings), select the **Normal** option.

1. Press the **MENU** button and then use **D / E** button to select the **PICTURE** menu.
2. Press the **G** button and then use **D / E** button to select **ACC**.
3. Press the **G** button and then use **D / E** button to select either: **Cool** (Preset), **Normal** (Default), or **Warm** (Preset).
4. Press the **ENTER** button to save.

Manual Color Temperature Control (ACC set to Off option)

- You can adjust red, green, or blue to any color temperature you prefer.

1. Press the **MENU** button and then use **D / E** button to select the **PICTURE** menu.
2. Press the **G** button and then use **D / E** button to select **ACC**.
3. Press the **G** button and then use **D / E** button to select **Off**.
4. Press the **G** button and then use **D / E** button to select **Red**, **Green** or **Blue**.
5. Use the **F / G** button to make appropriate adjustments.

- The adjustment range of **Red**, **Green**, and **Blue** is -30 ~ +30.

6. Press the **ENTER** button to save.

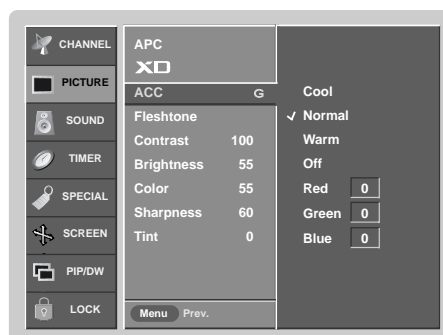

Picture Menu Options continued

Fleshtone (TV, Video1-2, Component 1-2, RGB-DTV, and DVI-DTV Mode only)

- Use Fleshtone to select the desired skin color option.

1. Press the **MENU** button and then use **D / E** button to select the **PICTURE** menu.
2. Press the **G** button and then use **D / E** button to select **Fleshtone**.
3. Press the **G** button and then use **F / G** button to make appropriate adjustments.
 - The adjustment range is 0 ~ 3.
4. Press the **ENTER** button to save.



sRGB (only RGB-PC, DVI-PC Modes)

- If the TV is connected to external equipment using sRGB, set sRGB to On to adjust for the color difference.

1. Press the **MENU** button and then use **D / E** button to select the **PICTURE** menu.
2. Press the **G** button and then use **D / E** button to select **sRGB**.
3. Press the **G** button and then use **D / E** button to select **On** or **Off**.
4. Press the **ENTER** button to save.



Manual Picture Control (**APC** set to **Off** option)

- You can adjust picture contrast, brightness, color, sharpness, and tint options to the levels you prefer.

1. Press the **MENU** button and then use **D / E** button to select the **PICTURE** menu.
2. Press the **G** button and then use **D / E** button to select the desired picture option (**Contrast, Brightness, Color, Sharpness, Tint**).
3. Press the **G** button and then use **F / G** button to make appropriate adjustments.
4. Press the **ENTER** button to save.





Sound Menu Options

DASP (Digital Auto Sound Processing)

- This function lets you enjoy the best sound without any special adjustment because the TV has the appropriate sound options based on the program content.
- If you adjust sound options (Treble and Bass) manually, DASP automatically changes to **Off**.

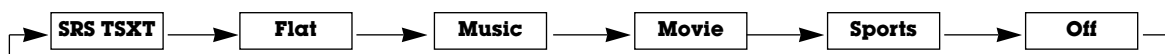
1. Press the **DASP** button repeatedly to select the appropriate sound setup as shown below.



- You can also adjust **DASP** in the **SOUND** menu.
- **SRS TSXT**, **Flat**, **Music**, **Movie**, and **Sports** are preset for good sound quality at the factory and cannot be changed.
-  is a trademark of SRS Labs, Inc.
- TruSurround XT technology is incorporated under license from SRS Labs, Inc.

BBE

- BBE High Definition Sound restores clarity and presence for better speech intelligibility and music realism.

1. Press the **MENU** button and then use **D / E** button to select the **SOUND** menu.
2. Press the **G** button and then use **D / E** button to select **BBE**.
3. Press the **G** button and then use **D / E** button to select **On** or **Off**.
4. Press the **ENTER** button to save.

- **BBE**. Manufactured under license from BBE Sound, Inc.
- Treble, Bass or BBE aren't suitable for **SRS TSXT** mode.

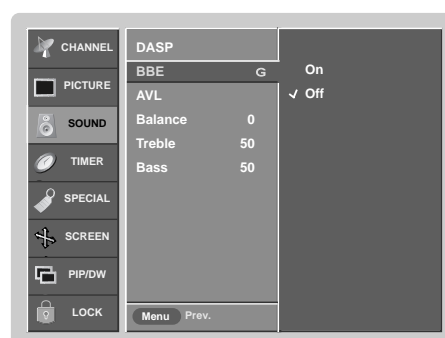

AVL (Auto Volume Leveler)

- AVL maintains an equal sound level; even if you change channels.

1. Press the **MENU** button and then use **D / E** button to select the **SOUND** menu.
2. Press the **G** button and then use **D / E** button to select **AVL**.
3. Press the **G** button and then use **D / E** button to select **On** or **Off**.
4. Press the **ENTER** button to save.

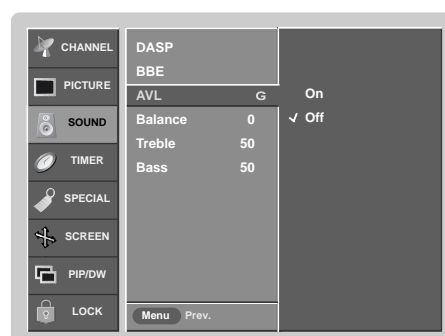

Sound Menu Options continued

Manual Sound Control (**DASP off** option and balance)

- You can adjust sound options Balance, Treble, and Bass to the levels you prefer.

1. Press the **MENU** button and then use **D / E** button to select the **SOUND** menu.
2. Press the **G** button and then use **D / E** button to select the desired sound option (**Balance, Treble, Bass**).
3. Press the **G** button and then use **F / G** button to make appropriate adjustments.
4. Press the **ENTER** button to save.

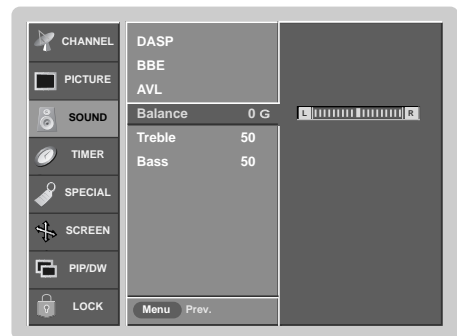

Stereo/SAP Broadcasts Setup

- The TV can receive MTS stereo programs and any SAP (Secondary Audio Program) that accompanies the stereo program; if the broadcaster transmits one additional sound signal in addition to the original one.
- Mono: The primary language is heard from left and right speakers. Signal mode is mono.
- Stereo: The primary language is heard from left and right speakers. Signal mode is stereo.
- SAP: The secondary language is heard from left and right speakers in mono sound.

1. Press the **MTS** button repeatedly.



- Select mono sound mode if the signal is not clear or in poor signal reception areas.
- **Stereo, SAP** modes are available only if included on the broadcast signal.

Timer Menu Options

Auto Clock Setup

- Set the time automatically through the PBS broadcast signal.
- The PBS channel signal includes information for the current time.
- Set the clock manually, if the current time is set incorrectly programmed by the auto clock function.

1. Press the **MENU** button and then use **D / E** button to select the **TIMER** menu.
2. Press the **G** button and then use **D / E** button to select **Clock**.
3. Press the **G** button and then use **D / E** button to select **Auto**.
4. Press the **G** button and then use **D / E** button to select the time zone for your viewing area. Your choices are: **Auto**, **E.S.T.** (Eastern Standard Time), **C.S.T.** (Central Standard Time), **M.S.T.** (Mountain Standard Time), **P.S.T.** (Pacific Standard Time), **Alaska**, and **Hawaii**.
5. Press the **G** button and then use **D / E** button to set **PBS Channel**.
6. Press the **G** button and then use **D / E** button to set Daylight Saving Time **Auto**, **On** or **Off**, depending on whether or not your viewing area observes Daylight Saving Time.
7. Press the **ENTER** button to save.



Manual Clock Setup

- If current time setting is wrong, reset the clock manually.

1. Press the **MENU** button and then use **D / E** button to select the **TIMER** menu.
2. Press the **G** button and then use **D / E** button to select **Clock**.
3. Press the **G** button and then use **D / E** button to select **Manual**.
4. Press the **G** button and then use **D / E** button to set the hour.
5. Press the **G** button and then use **D / E** button to set the minutes.
6. Press the **ENTER** button to save.

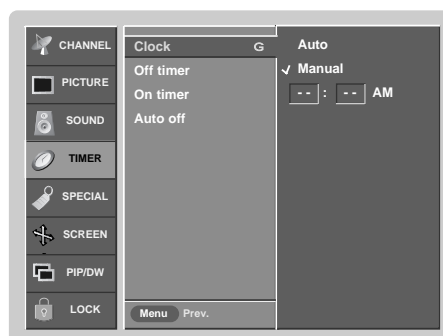

On/Off Timer Setup

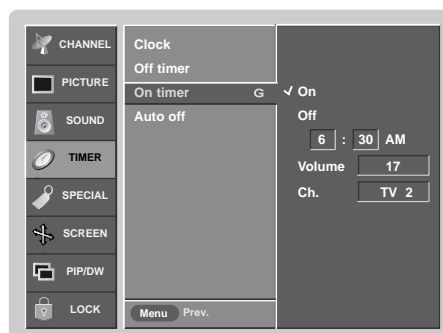

- Timer function operates only if current time has been set.
- Off-Timer function overrides On-Timer function if they are set both set to the same time.
- The TV must be in standby mode for the On-Timer to work.
- If you do not press any button within 2 hours after the TV turns on with the On Timer function, the TV will automatically revert to standby mode.

1. Press the **MENU** button and then use **D / E** button to select the **TIMER** menu.
2. Press the **G** button and then use **D / E** button to select **Off timer** or **On timer**.
3. Press the **G** button and then use **D / E** button to select **On**.
 - To cancel **On/Off timer** function, select **Off**.
4. Press the **G** button and then use **D / E** button to set the hour.
5. Press the **G** button and then use **D / E** button to set the minutes.
6. **For only On timer function**
 - Press the **G** button and then use **D / E** button to set the sound level at turn-on.
 - Press the **G** button and then use **D / E** button to select the channel at turn-on.
7. Press the **ENTER** button to save.



Timer Menu Options continued

Sleep Timer

- The Sleep Timer turns the TV off at the preset time. Note that this setting is cleared when the TV is turned off.
- 1. Press the **SLEEP** button repeatedly to select the number of preset minutes. First the  **Min** option appears on the screen, followed by the following sleep timer turn off times:
10, 20, 30, 60, 90, 120, 180, and 240 minutes.
- 2. When the number of minutes you want is displayed on the screen, press the **ENTER** button. The timer begins to count down from the number of minutes selected.
- 3. To check the remaining minutes before the TV turns off, press the **SLEEP** button once.
- 4. To cancel the Sleep Timer, press the **SLEEP** button repeatedly until  **Min** appears.

Auto Off

- If set to on and there is no input signal, the TV turns off automatically after 10 minutes.
- 1. Press the **MENU** button and then use **D / E** button to select the **TIMER** menu.
- 2. Press the **G** button and then use **D / E** button to select **Auto off**.
- 3. Press the **G** button and then use **D / E** button to select **On** or **Off**.
- 4. Press the **ENTER** button to save.



Special Menu Options

Key Lock

- The TV can be set up so that it can only be used with the remote control.
- This feature can be used to prevent unauthorized viewing by locking out the front panel controls.
- This TV is programmed to remember which option it was last set to even if you turn the TV off.

1. Press the **MENU** button and then use **D / E** button to select the **SPECIAL** menu.
2. Press the **G** button and then use **D / E** button to select **Key lock**.
3. Press the **G** button and then use **D / E** button to select **On** or **Off**.
4. Press the **ENTER** button to save.

- With the Key lock On, the display '  **Key lock**' appears on the screen if any button on the front panel is pressed.

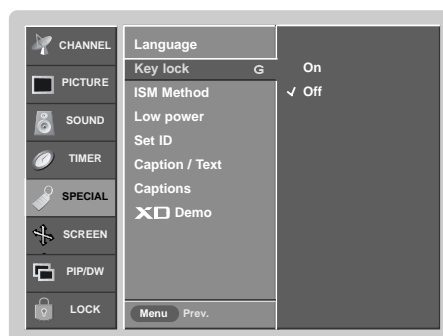

ISM (Image Sticking Minimization) Method

- A frozen still picture from a PC/video game displayed on the screen for prolonged periods will result in a ghost image remaining even when you change the image. Avoid allowing a fixed image to remain on the TV's screen for a long period of time.

1. Press the **MENU** button and then use **D / E** button to select the **SPECIAL** menu.
2. Press the **G** button and then use **D / E** button to select **ISM Method**.
3. Press the **G** button and then use **D / E** button to select either **Normal**, **White wash**, **Orbiter** or **Inversion**.

• Normal

If image sticking is never a problem, ISM is not necessary - set to Normal.

• White wash

White Wash removes permanent images from the screen. Note: An excessive permanent image may be impossible to clear entirely with White Wash. To return to normal viewing, press any button.

• Orbiter

Orbiter may help prevent ghost images. However, it is best not to allow any fixed image to remain on the screen. To avoid a permanent image on the screen, the image will move every 2 minutes: Right → Right → Downside → Downside → Left → Left → Upside → Upside.

• Inversion

Inversion will automatically invert the TV panel color every 30 minutes.

4. Press the **ENTER** button to save.

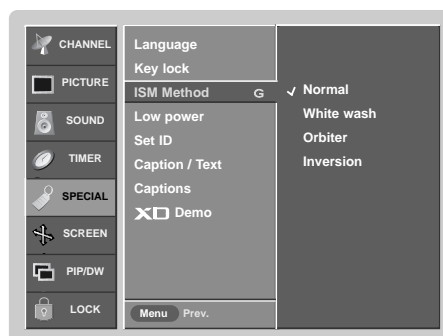

Special Menu Options continued

Low Power

- Low power reduces the plasma display power consumption.
1. Press the **MENU** button and then use **D / E** button to select the **SPECIAL** menu.
 2. Press the **G** button and then use **D / E** button to select **Low power**.
 3. Press the **G** button and then use **D / E** button to select **On** or **Off**.
 - When you select **On**, the screen darkens.
 4. Press the **ENTER** button to save.

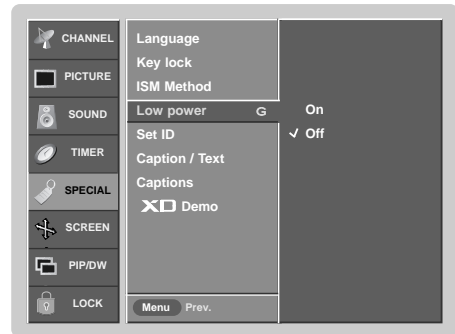

XD Demo

- Use it to see the difference between XD Demo on and XD Demo off.
1. Press the **MENU** button and then use **D / E** button to select the **SPECIAL** menu.
 2. Press the **G** button and then use **D / E** button to select **XD Demo**.
 3. Press the **G** button to begin **XD Demo**.
 4. Press the **EXIT** button to stop **XD Demo**.

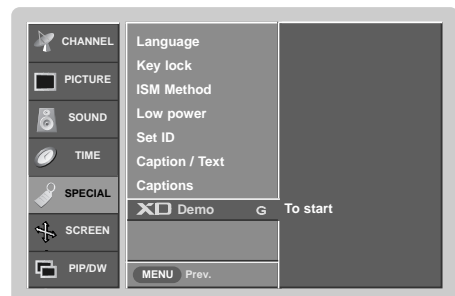

Closed Captions

Closed captioning is a process which converts the audio portion of a television program into written words which then appear as subtitles on the television screen. Closed captions allow viewers to read the dialogue and narration of television programs.

Using Closed Captions

Captions are the subtitles of the dialogue and narration of television programs. For prerecorded programs, program dialogue can be arranged into captions in advance. Its possible to caption a live program by using a process called real-time captioning, which creates captions instantly. Real-time captioning is normally done by professional reporters using a machine shorthand system and computer for translation into English.

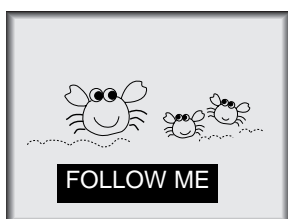

Captioning is an effective system for the hearing-impaired, and it can also aid in teaching language skills.

- The picture at left shows a typical caption.

Caption Tips

- Not all TV broadcasts include closed caption signals.
- Sometimes TV stations broadcast four different caption signals on the same channel. By selecting **CC 1 to CC 2**, you can choose which signal you view. **CC 1** is usually the signal with the captions, while **Another mode** might show demonstration or programming information.
- Your TV might not receive caption signals normally in the following situations.

1. Poor reception conditions are encountered:



• IGNITION:

Picture may flutter, drift, suffer from black spots, or horizontal streaking. Usually caused by interference from automobile ignition systems, neon lamps, electrical drills, and other electrical appliances.



• GHOSTS:

Ghosts are caused when the TV signal splits and follows two paths. One is the direct path and the other is reflected off tall buildings, hills or other objects. Changing the direction or position of the antenna may improve reception.



• SNOW:

If your receiver is located at the weak, fringe area of a TV signal, your picture may be marred by small dots. It may be necessary to install a special antenna to improve the picture.

2. An old, bad, or illegally recorded tape is being played.
3. Strong, random signals from a car or airplane interfere with the TV signal.
4. The signal from the antenna is weak.
5. The program wasn't captioned when it was produced, transmitted, or taped.

Captions

1. Use the **CAPTION** button repeatedly to select Caption **Off**, **EZ Mute**, or **On**.
 - **EZ Mute** shows the selected captions option (if available on program) when the TV sound is muted.
2. Press the **ENTER** button to save.

Caption/Text

1. Press the **MENU** button and then use **D / E** button to select the **SPECIAL** menu.
2. Press the **G** button and then use **D / E** button to select **Caption / Text**.
3. Press the **G** button and then use **D / E** button to select caption: **CC1, CC2, CC3, CC4, Text1, Text2, Text3, or Text4**.

• CAPTION

The term for the words that scroll across the bottom of the TV screen; usually the audio portion of the program provided for the hearing impaired.

• TEXT

The term for the words that appear in a large black frame and almost cover the entire screen; usually messages provided by the broadcaster.

4. Press the **ENTER** button to save.

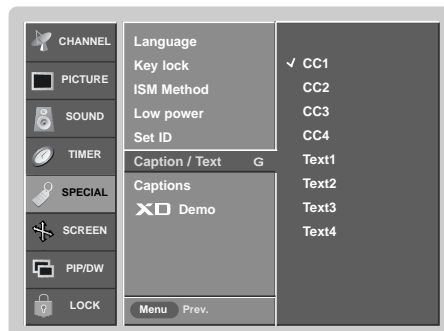

Screen Menu Options

Auto Adjustment

- RGB (PC) mode only; This function doesn't work for RGB-DTV mode.
- Automatically adjusts picture position and minimizes image shaking.
- After adjustment, if the image is still not correct, your TV is functioning properly but needs further adjustment.
- The **Auto config.** and **Manual config.** are not active in DVI mode.

1. Press the **MENU** button and then use **D / E** button to select the **SCREEN** menu.
2. Press the **G** button and then use **D / E** button to select **Auto config.**
3. Press the **G** button to run Auto configure.
 - When **Auto config.** has finished, **OK** will be shown on screen.
 - If the position of the image is still not correct, try Auto adjustment again.
4. In RGB (PC) mode, if the image needs to be adjusted more after using **Auto config.**, you can make further adjustments with the **Manual config.** option.

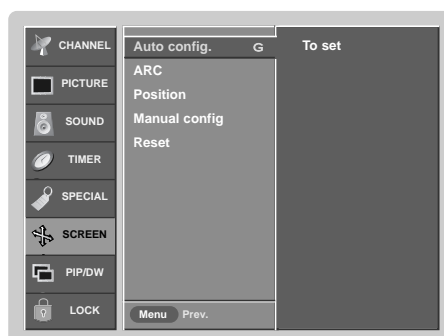

Setting Picture Format

- Caution: If a 4:3 fixed image is on the screen for a long time, it may remain visible.
- Set every aspect ratio for TV, Video, Component 480i sources.
- Use 4:3, or 16:9 for other RGB-PC and DVI-PC sources.
- Horizon is not available for Component (480p,720p,1080i), DTV (480p,720p,1080i) sources.

1. Press the **ARC** button repeatedly to select the desired picture format. You can also adjust **ARC** in the **SCREEN** menu.
 - **4:3**
Choose **4:3** when you want to view a picture with an original 4:3 aspect ratio, with black bars appearing at both the left and right sides.
 - **16:9**
Choose **16:9** when you want to adjust the picture horizontally, in a linear proportion to fill the entire screen.
 - **Horizon**
Choose **Horizon** when you want to adjust the picture in a non-linear proportion, that is, more enlarged at both sides, to create a spectacular view.
 - **Zoom**
- Choose **Zoom** when you want to view the picture without any alteration. However, the top and bottom portions of the picture will be cropped.

Screen Position

- This function works in the following modes:
RGB-PC, RGB-DTV (480p,720p,1080i), DVI-DTV (480p,720p,1080i), COMPONENT (480p,720p,1080i).

1. Press the **MENU** button and then use **D / E** button to select the **SCREEN** menu.
2. Press the **G** button and then use **D / E** button to select **Position**.
3. Press the **G** button and then use **D / E / F / G** button to adjust the position.
4. Press the **ENTER** button to save.

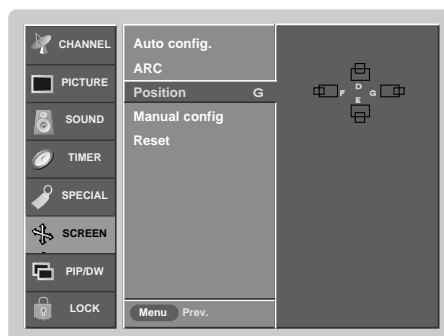

Manual Configure (RGB-PC mode only)

- If the image still isn't clear after auto adjustment and especially if characters are still jittery, adjust the picture Phase manually.
- To correct the screen size, adjust **Clock**.

1. Press the **MENU** button and then use **D / E** button to select the **SCREEN** menu.
2. Press the **G** button and then use **D / E** button to select **Manual config.**
3. Press the **G** button and then use **D / E** button to select **Phase** or **Clock**.
4. Use the **F / G** button to make appropriate adjustments.
 - The **Phase** adjustment range is 0 ~ 30.
 - The **Clock** adjustment range is -127 ~ +128.
5. Press the **ENTER** button to save.

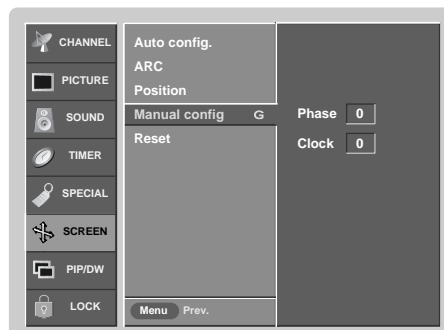

Selecting VGA mode (RGB-PC mode only)

- To see a normal picture, match the resolution of RGB mode and selection of VGA mode.
- RU-42PZ71 model only.

1. Press the **MENU** button and then use **D / E** button to select the **SCREEN** menu.
2. Press the **G** button and then use **D / E** button to select **VGA Mode**.
3. Press the **G** button and then use **D / E** button to select the desired VGA resolution.
4. Press the **ENTER** button to save.

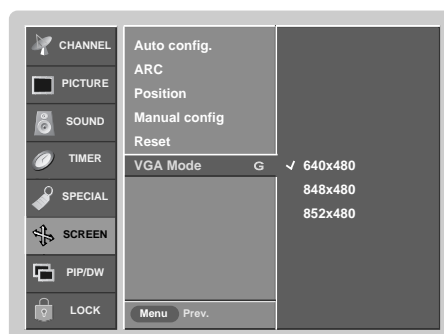

Selecting XGA mode (RGB-PC mode only)

- To see a normal picture, match the resolution of RGB mode and selection of XGA mode.

1. Press the **MENU** button and then use **D / E** button to select the **SCREEN** menu.
2. Press the **G** button and then use **D / E** button to select **XGA Mode**.
3. Press the **G** button and then use **D / E** button to select the desired XGA resolution.
4. Press the **ENTER** button to save.

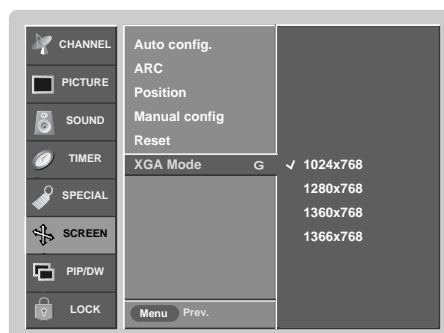

Screen Adjustments (TV, Video1-2 and Component 480i mode only)

- Use this function to correct jittering or picture instability while viewing a video tape.

1. Press the **MENU** button and then use **D / E** button to select the **SCREEN** menu.
2. Press the **G** button and then use **D / E** button to select **Screen adj.**.
3. Press the **G** button and then use **D / E** button to select **TV** or **VCR**.
 - Select the **VCR** option if watching a VCR.
 - Select the **TV** option for other equipment. (Except VCR)
4. Press the **ENTER** button to save.



Cinema Mode Setup (TV, Video1-2 and Component 480i mode only)

- Sets up the TV for the best picture appearance for viewing movies.

1. Press the **MENU** button and then use **D / E** button to select the **SCREEN** menu.
2. Press the **G** button and then use **D / E** button to select **Cinema**.
3. Press the **G** button and then use **D / E** button to select **On** or **Off**.
4. Press the **ENTER** button to save.

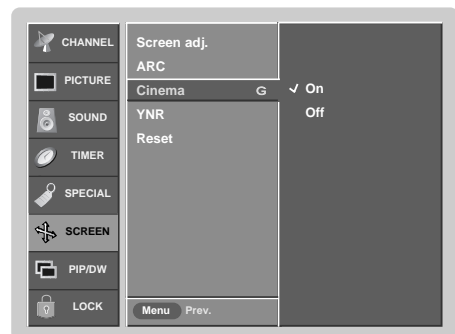

Luminance Noise Reduction (TV, Video 1-2 and Component 480i modes only)

- Use YNR to reduce the picture noise that may appear on the screen.

1. Press the **MENU** button and then use **D / E** button to select the **SCREEN** menu.
2. Press the **G** button and then use **D / E** button to select **YNR**.
3. Press the **G** button and then use **D / E** button to select **On** or **Off**.
4. Press the **ENTER** button to save.

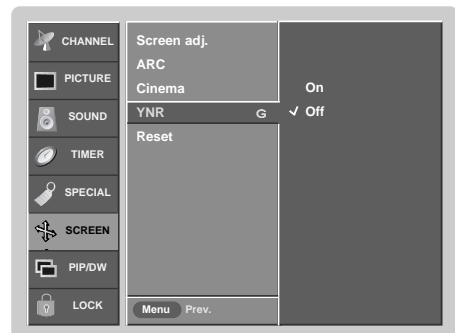

Screen Menu Options continued

Initializing (Reset to original factory value)

- Use the Reset option to initialize the adjusted settings.

1. Press the **MENU** button and then use **D / E** button to select the **SCREEN** menu.
2. Press the **G** button and then use **D / E** button to select **Reset**.
3. Press the **G** button.

- You can initialize Position, Split zoom, PIP Transparency, PIP position, PIP size and sub picture size for double window.

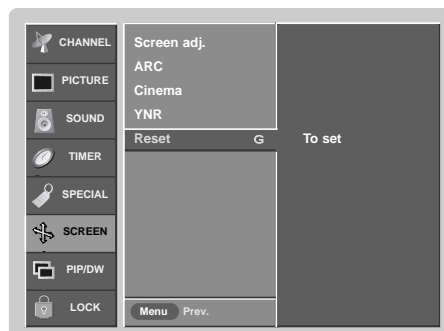

Split Zoom

- Enlarges the picture in correct proportions.
- Split Zoom can be used for all input sources.
- In 2-Split Zoom mode, you can only move the image up or down.
- If an image is enlarged, a section can be viewed without using Split Zoom.

1. Press the **SPLIT ZOOM** button repeatedly to select either 2, 4, or 9 Split Zoom.

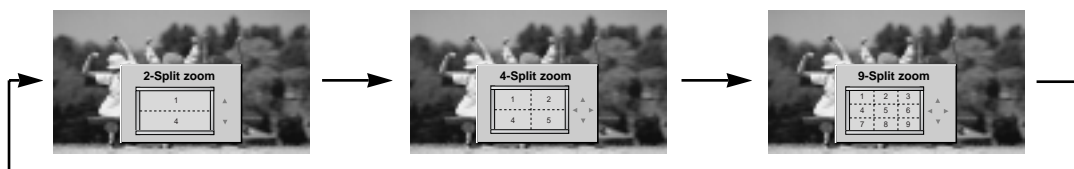

2. Press the number button corresponding to the section you wish to enlarge. You can move within the enlarged picture using the **D / E / F / G** button. To return to normal viewing, press the **SPLIT ZOOM** button again.

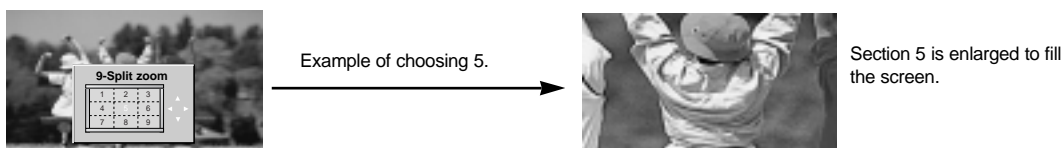

Lock Menu Options

Parental Control can be used to block specific channels, ratings and other viewing sources.

The Parental Control Function (V-Chip) is used to block program viewing based on the ratings sent by the broadcasting station. The default setting is to allow all programs to be viewed. Viewing can be blocked by the type of program and by the categories chosen to be blocked. It is also possible to block all program viewing for a time period. To use this function, the following must be done :

1. Set ratings and categories to be blocked.
2. Specify a password
3. Enable the lock

V-Chip rating and categories

Rating guidelines are provided by broadcasting stations. Most television programs and television movies can be blocked by TV Rating and/or Individual Categories. Movies that have been shown at the theaters or direct-to-video movies use the Movie Rating System (MPAA) only.

Ratings for Movies previously shown in theaters:

Movie Ratings :

- Blocking Off (Permits all programs)
- G (General audience)
- PG (Parental guidance suggested)
- PG-13 (Parents strongly cautioned)
- R (Restricted)
- NC-17 (No one 17 and under admitted)
- X (Adult only)

If you set PG-13 : G and PG movies will be available , PG-13, R, NC-17 and X will be blocked.

Ratings for Television programs including made-for-TV movies :

General TV Ratings:

- Blocking Off
- TV-G (general audience) (individual categories do not apply)
- TV-PG (parental guidance suggested)
- TV-14 (14 years and older)
- TV-MA (mature audience)

Children TV Ratings:

- Blocking Off
- TV-Y (youth) (individual content categories do not apply)
- TV-Y7 (youth, 7 years and up)

Content Categories:

- Dialog - sexual dialogue (applies to TV-PG, TV-14)
- Language - adult language (applies to TV-PG, TV-14, TV-MA)
- Sex scenes - sexual situations (applies to TV-PG, TV-14, TV-MA)
- Violence (applies to TV-PG, TV-14, TV-MA)
- F Violence - fantasy violence (applies only to TV-Y7)

Aux. Block

- Video 1, 2 (On, Off)
- Component 1, 2 (On, Off)
- RGB, DVI (On, Off)

Parental Lock Setup

- Lets you set up blocking schemes to block specific channels, ratings, and external viewing sources.
- A password is required to gain access to this menu if the Lock System is turned on

1. Press the **MENU** button and then use **D / E** button to select the **LOCK** menu. Then, press the **G** button

- If **Lock** is already set, enter the password as requested.
- The TV is set up with the initial password "0-0-0-0".

2. Use the **D / E** button to choose from the following Lock Menu options. Once the option is selected, change the settings to your preference.

- **Lock on/off:** Activates or disables the blocking scheme you set up previously.
- **Set Password:** Change the password by inputting a new password twice.
- **MPAA (Movie Rating):** Blocks movies according to the movie ratings limits specified, so children cannot view certain movies. You can set the ratings limit by blocking out all the movies with the ratings above a specified level. Keep in mind that the movie ratings limit only applies to movies shown on TV, not TV programs, such as soap operas.
- **TV Rating-Children:** Prevents children from watching certain children's TV programs, according to the ratings limit set. The children rating does not apply to other TV programs. Unless you block certain TV programs intended for mature audiences in the TV Rating - sub menu, your children can view those programs.
- **TV Rating-General:** Based on the ratings, blocks certain TV programs that you and your family do not want to view.
- **Aux. Block:** Enables you to select a source to block from the external source devices you have hooked up.

3. Press the **ENTER** button to save.

Note

- If you ever forget your password, key in '7', '7', '7', '7' on the remote control.

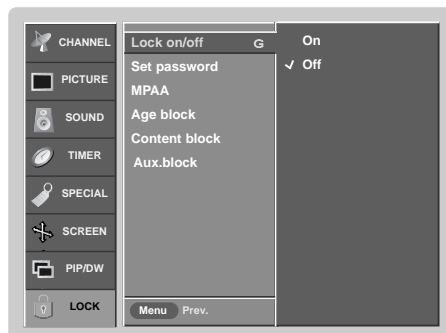

PIP (Picture-In-Picture)/Double Window Feature

- PIP lets you view 2 different inputs pictures (sources) on your TV screen at the same time. One source will be large, and the other source will show a smaller inset image.
- Double Window mode splits the screen into 2, allowing 2 picture sources to be shown on the TV screen at the same time. Each source is given half the screen.

Watching PIP/Double Window

Press the **PIP/DW** button to access the sub picture. Each press of PIP changes the PIP options as shown below.



Swapping the PIP/Double Window

Use the **SWAP** button to switch the main and sub pictures.

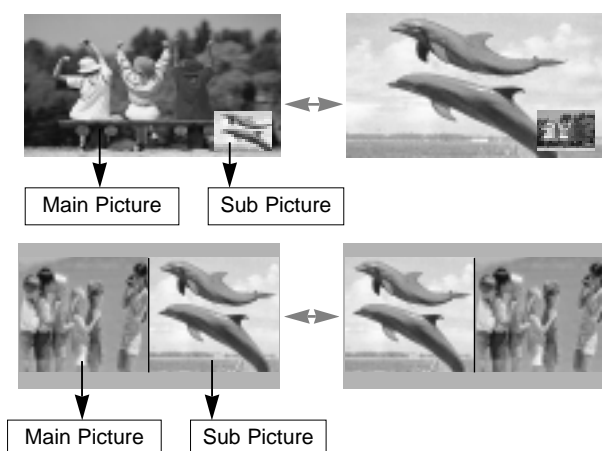

TV Program selection for PIP

Press the **PIPCH+ / PIPCH-** button to select a channel for the sub picture in PIP mode.

Selecting an Input Signal Source for PIP/Double Window

Use the **PIP INPUT** button to select the input source for the sub picture. Each press of **PIP INPUT** button changes the PIP source.

Main Picture Source	Available Sub Picture Sources
TV, Video 1-2, Component 480i	TV, Video 1-2, Component 480i/480p/720p/1080i, RGB and DVI
Component 480p/720p/1080i, RGB and DVI	TV, Video 1-2, Component 480i

Moving the PIP (PIP Mode only)

Press the **POSITION** button.

Press the **D / E / F / G** button repeatedly until desired position is achieved. The sub picture moves up/down/left/right.

- You can also move the PIP position with **Win.position** in the **PIP/DW** menu.



PIP Size

Press the **WIN.SIZE** button and then use **F / G** button to change the sub picture size.

- Using the Win.size function in Double Window mode, main and sub picture sizes are changed simultaneously.
- Using the Win.size function in PIP mode, sub picture size is changed.
- You can also change the sub picture size with **Win.size** in the **PIP/DW** menu.



PIP Transparency (PIP Mode only)

- To make the PIP clear or opaque

1. Press the **MENU** button and then use **D / E** button to select the **PIP/DW** menu.
2. Press the **G** button and then use **D / E** button to select **PIP Transparency**.
3. Press the **G** button and then use **D / G** button to adjust PIP transparency.
4. Use the **F / G** button to make appropriate adjustments.
 - The adjustment range of **PIP Transparency** is 0 ~ 10.
5. Press the **ENTER** button to save.

External Control Device Setup

- Connect the RS-232C input jack to an external control device (such as a computer or an A/V control system) and control the Monitor's functions externally.
- Connect the serial port of the control device to the RS-232C jack on the Monitor back panel.
- RS-232C connection cables are not supplied with the Monitor.

RS-232C Setup

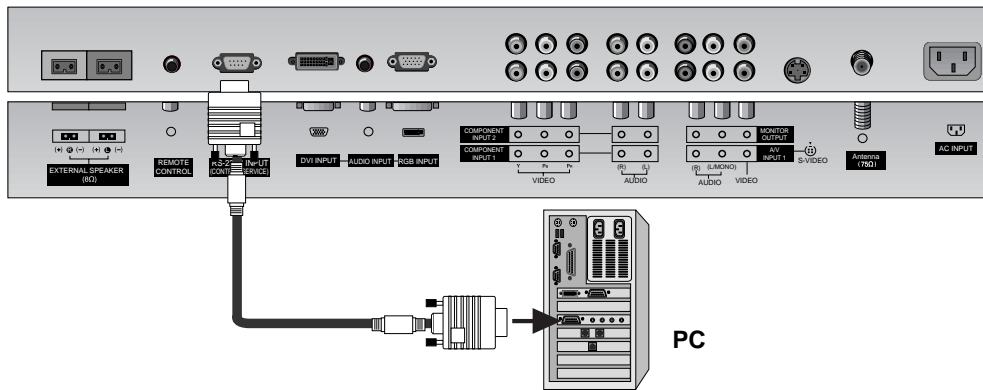

Type of Connector; D-Sub 9-Pin Male

No.	Pin name
1	No connection
2	RXD (Receive data)
3	TXD (Transmit data)
4	DTR (DTE side ready)
5	GND
6	DSR (DCE side ready)
7	RTS (Ready to send)
8	CTS (Clear to send)
9	No Connection

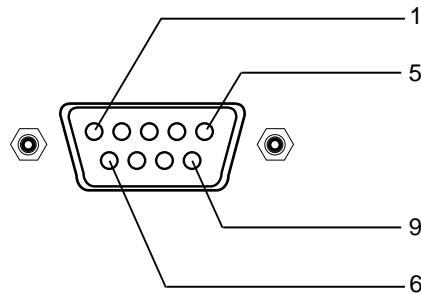

RS-232C Configurations

7-Wire Configurations (Standard RS-232C cable)

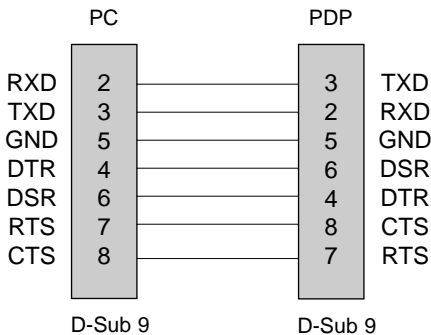

3-Wire Configurations (Not standard)

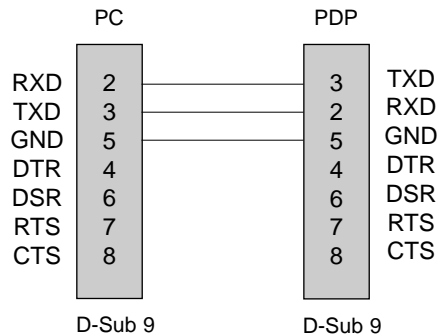

Set ID

- Use this function to specify a monitor ID number.
- Refer to 'Real Data Mapping 1'. See page 37.

1. Press the **MENU** button and then use **D / E** button to select the **SPECIAL** menu.
2. Press the **G** button and then use **D / E** button to select **Set ID**.
3. Press the **G** button and then use **F / G** button to adjust **Set ID** to choose the desired monitor ID number. The adjustment range of **Set ID** is 1 ~ 99.
4. Press the **ENTER** button to save.

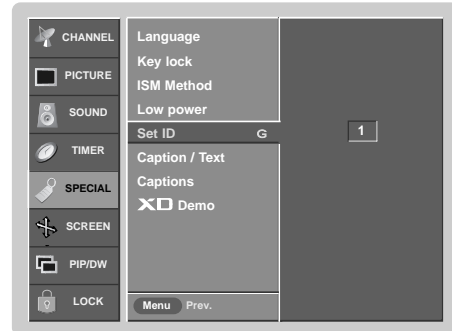

Communication Parameters

- Baud rate :9600 bps (UART)
- Data length : 8 bits
- Parity : None
- Stop bit : 1 bit
- Communication code : ASCII code

* Use a crossed (reverse) cable.

Command Reference List

	COMMAND 1	COMMAND 2	DATA (Hexadecimal)
01. Power	k	a	0 ~ 1
02. Input Select	k	b	0 ~ 6
03. Aspect Ratio	k	c	0 ~ 3
04. Screen Mute	k	d	0 ~ 1
05. Volume Mute	k	e	0 ~ 1
06. Volume Control	k	f	0 ~ 64
07. Contrast	k	g	0 ~ 64
08. Brightness	k	h	0 ~ 64
09. Color	k	i	0 ~ 64
10. Tint	k	j	0 ~ 64
11. Sharpness	k	k	0 ~ 64
12. OSD Select	k	l	0 ~ 1
13. Remote Control Lock Mode	k	m	0 ~ 1
14. PIP/DW	k	n	0 ~ 3
15. Split Zoom	k	p	0 ~ 99
16. PIP Position	k	q	0 ~ 3
17. Treble	k	r	0 ~ 64
18. Bass	k	s	0 ~ 64
19. Balance	k	t	0 ~ 64
20. Color Temperature	k	u	0 ~ 3
21. Red Adjustment	k	v	0 ~ 3C
22. Green Adjustment	k	w	0 ~ 3C
23. Blue Adjustment	k	\$	0 ~ 3C
24. PIP Input Source	k	y	0 ~ 6
25. Abnormal State	k	z	0 ~ a
26. ISM Method	j	p	0 ~ 3
27. Low Power	j	q	0 ~ 1
28. Orbiter Time Setting	j	r	1 ~ FE
29. Orbiter Pixel Setting	j	s	1~9
30. Picture Size	j	t	0 ~ 14
31. Auto Config	j	u	1

	COM- MAND 1	COM- MAND 2	DATA 0 (Hexadecimal)	DATA 1 (Hexadecimal)	DATA 2 (Hexadecimal)	DATA 3 (Hexadecimal)
32. Tune Command	m	a	01 ~ 7D	0	0	mainsub/TuneBand
33. Channel Add/Del	m	b	0 ~ 1			
34. Key	m	c	Key code			

Transmission / Receiving Protocol

Transmission

[Command1][Command2][][Set ID][][Data][Cr]

- * [Command 1]: First command to control PDP set. (j, k or m)
- * [Command 2]: Second command to control PDP set.
- * [Set ID]: You can adjust the set ID to choose desired monitor ID number in Special menu. Adjustment range is 1 ~ 99. When selecting Set ID '0', every connected PDP set is controlled. Set ID is indicated as decimal (1~99) on menu and as Hexa decimal (0x0~0x63) on transmission/receiving protocol.
- * [DATA]: To transmit command data.
Transmit 'FF' data to read status of command.
- * [Cr]: Carriage Return
ASCII code '0x0D'
- * []: ASCII code 'space (0x20)'

OK Acknowledgement

[Command2][][Set ID][][OK][Data][x]

- * The Monitor transmits ACK (acknowledgement) based on this format when receiving normal data. At this time, if the data is data read mode, it indicates present status data. If the data is data write mode, it returns the data of the PC computer.

Error Acknowledgement

[Command2][][Set ID][][NG][Data][x]

- * The Monitor transmits ACK (acknowledgement) based on this format when receiving abnormal data from non-viable functions or communication errors.

- Data
- 1: Illegal Code
 - 2: Not supported function
 - 3: Wait more time

09. Color (Command2:i)

G To adjust the screen color.
You can also adjust color in the Picture menu.

Transmission

[k][i][][Set ID][][Data][Cr]

Data Min : 0 ~ Max : 64

- Refer to 'Real data mapping 1'. See page 38.

Acknowledgement

[i][][Set ID][][OK][Data][x]

10. Tint (Command2:j)

G To adjust the screen tint.
You can also adjust tint in the Picture menu.

Transmission

[k][j][][Set ID][][Data][Cr]

Data Red : 0 ~ Green : 64

- Refer to 'Real data mapping 1'. See page 38.

Acknowledgement

[j][][Set ID][][OK][Data][x]

11. Sharpness (Command2:k)

G To adjust the screen sharpness.
You can also adjust sharpness in the Picture menu.

Transmission

[k][k][][Set ID][][Data][Cr]

Data Min: 0 ~ Max: 64

- Refer to 'Real data mapping 1'. See page 38.

Acknowledgement

[k][][Set ID][][OK][Data][x]

12. OSD Select (Command2:l)

G To select OSD (On Screen Display) on/off.

Transmission

[k][l][][Set ID][][Data][Cr]

Data 0: OSD off 1: OSD on

Acknowledgement

[l][][Set ID][][OK][Data][x]

13. Remote Control Lock Mode (Command2:m)

G To lock the remote control and the front panel controls on the monitor.

Transmission

[k][m][][Set ID][][Data][Cr]

Data 0: Lock off 1: Lock on

Acknowledgement

[m][][Set ID][][OK][Data][x]

- If you're not using the remote control and front panel controls on the monitor, use this mode. When main power is on/off, remote control lock is released.

14. PIP / DW (Command2:n)

G To control the PIP (Picture In picture)/DW (Double Window).
You can also control the PIP/DW using the PIP/DW button on the remote control or in the PIP/DW menu.

Transmission

[k][n][][Set ID][][Data][Cr]

Data 0: PIP/DW off 2: DW1
1: PIP 3: DW2Acknowledgement

[n][][Set ID][][OK][Data][x]

15. Split Zoom (Command2:p)

G To operate split zoom function and select the split zoom section number.

Transmission

[k][p][][Set ID][][Data][Cr]

Data Min: 0 ~ Max:99

- Refer to 'Real data mapping 2'.

Acknowledgement

[p][][Set ID][][OK][Data][x]

*** Real data mapping 2**

0 : Reset split zoom
21 : Selection 1 of 2 split zoom
24 : Selection 4 of 2 split zoom
41 : Selection 1 of 4 split zoom
42 : Selection 2 of 4 split zoom
44 : Selection 4 of 4 split zoom
45 : Selection 5 of 4 split zoom
91 : Selection 1 of 9 split zoom
⋮
99 : Selection 9 of 9 split zoom

16. PIP Position (Command2:q)

G To select sub picture position for PIP.
You can also adjust the sub picture position using WIN.POSITION on the remote control or in the PIP/DW menu.

Transmission

[k][q][][Set ID][][Data][Cr]

Data 0: Right down on screen
1: Left down on screen
2: Left up on screen
3: Right up on screenAcknowledgement

[q][][Set ID][][OK][Data][x]

17. Treble (Command2:r)

G To adjust treble.
You can also adjust treble in the Sound menu.

Transmission

[k][r][][Set ID][][Data][Cr]

Data Min: 0 ~ Max: 64

- Refer to 'Real data mapping 1'. See page 38.

Acknowledgement

[r][][Set ID][][OK][Data][x]

18. Bass (Command2:s)

G To adjust bass.
You can also adjust bass in the Sound menu.

Transmission

[k][s][][Set ID][][Data][Cr]

Data Min: 0 ~ Max: 64

- Refer to 'Real data mapping 1'. See page 38.

Acknowledgement

[s][][Set ID][][OK][Data][x]

19. Balance (Command2:t)

G To adjust balance.
You can also adjust balance in the Sound menu.

Transmission

[k][t][][Set ID][][Data][Cr]

Data Min: 0 ~ Max: 64

- Refer to 'Real data mapping 1'. See page 38.

Acknowledgement

[t][][Set ID][][OK][Data][x]

20. Color Temperature (Command2:u)

G To adjust color temperature.
You can also adjust ACC in the Picture menu.

Transmission

[k][u][][Set ID][][Data][Cr]

Data 0: Cool 1: Normal 2: Warm 3: Off

Acknowledgement

[u][][Set ID][][OK][Data][x]

21. Red Adjustment (Command2:v)

G To adjust red in color temperature.

Transmission

[k][v][][Set ID][][Data][Cr]

Data Min: 0 ~ Max: 3C

- Refer to 'Real data mapping 3' as shown right.

Acknowledgement

[v][][Set ID][][OK][Data][x]

22. Green Adjustment (Command2:w)

G To adjust green in color temperature.

Transmission

[k][w][][Set ID][][Data][Cr]

Data Min: 0 ~ Max: 3C

- Refer to 'Real data mapping 3' as shown right.

Acknowledgement

[w][][Set ID][][OK][Data][x]

23. Blue Adjustment (Command2:\$)

G To adjust blue in color temperature.

Transmission

[k][\$][][Set ID][][Data][Cr]

Data Min: 0 ~ Max: 3C

- Refer to 'Real data mapping 3' as shown below.

Acknowledgement

[\$][][Set ID][][OK][Data][x]

*** Real data mapping 3**

- 0 : -30
- 1 : -29
- 2 : -28
- ⋮
- 1E : 0
- ⋮
- 3A : +28
- 3B : +29
- 3C : +30

24. PIP Input Select (Command2:y)

G To select input source for sub picture in PIP mode.

Transmission

[k][y][][Set ID][][Data][Cr]

- | | |
|-----------------|-----------------|
| Data 0 : TV | 4 : Component 2 |
| 1 : Video 1 | 5 : RGB |
| 2 : Video 2 | 6 : DVI |
| 3 : Component 1 | |

Acknowledgement

[y][][Set ID][][OK][Data][x]

25. Abnormal State (Command2:z)

G To recognize an abnormal state.

Transmission

[k][z][][Set ID][][FF][Cr]

Data FF:Read

Acknowledgement

[z][][Set ID][][OK][Data][x]

- Data 0: Normal (Power on and signal exist)
- 1: No signal (Power on).
 - 2: Turn the monitor off with remote control.
 - 3: Turn the monitor off with Sleep Time function.
 - 4: Turn the monitor off with RS-232C function.
 - 5: 5V down.
 - 6: AC down.
 - 7: Turn the monitor off with Fan Alarm function.
 - 8: Turn the monitor off with Off Time function.
 - 9: Turn the monitor off with Auto Off function.
 - a: Turn the monitor off with On Time function.
- (If you do not press any button within 2 hours after the TV turns on with the On Timer function, the TV will automatically revert to standby mode.)

IR Codes

How to Connect

G Connect your wired remote control to the Remote Control port on the Monitor.

Remote Control IR Code

G Output waveform

Single pulse, modulated with 37.917KHz signal at 455KHz

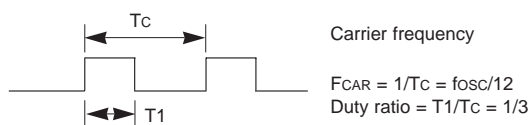

G Configuration of frame

- 1st frame

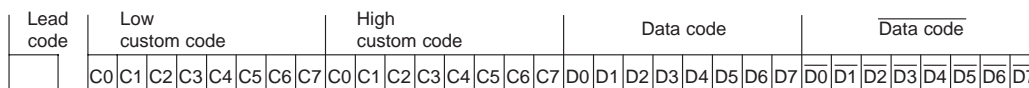

- Repeat frame

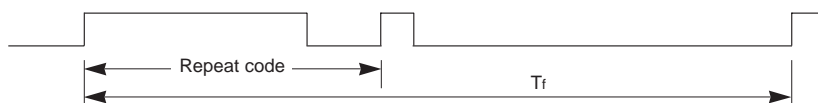

G Lead code



G Repeat code

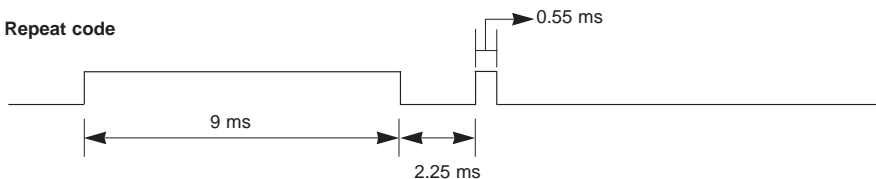

G Bit description

- Bit "0"

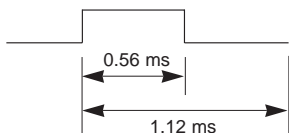

- Bit "1"

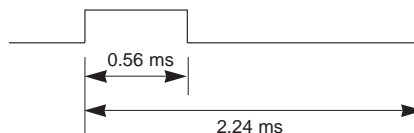

G Frame interval : Tf

The waveform is transmitted as long as a key is depressed.

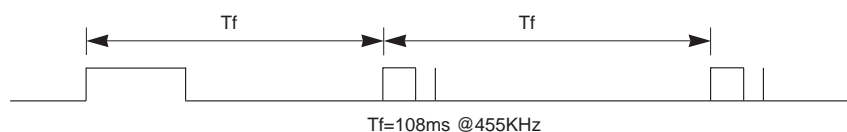

Code (Hexa)	Function	Note
00	CH (D)	R/C Button
01	CH (E)	R/C Button
02	VOL (G)	R/C Button
03	VOL (F)	R/C Button
08	POWER	R/C Button (Power On/Off)
C4	POWER ON	Discrete IR Code (Only Power On)
C5	POWER OFF	Discrete IR Code (Only Power Off)
09	MUTE	R/C Button
10	Number Key 0	R/C Button
11	Number Key 1	R/C Button
12	Number Key 2	R/C Button
13	Number Key 3	R/C Button
14	Number Key 4	R/C Button
15	Number Key 5	R/C Button
16	Number Key 6	R/C Button
17	Number Key 7	R/C Button
18	Number Key 8	R/C Button
19	Number Key 9	R/C Button
0B	TV/VIDEO	R/C Button
98	MULTIMEDIA	R/C Button
D6	TV	Discrete IR Code (Input TV Selection)
5A	VIDEO1	Discrete IR Code (Input VIDEO1 Selection)
D0	VIDEO2	Discrete IR Code (Input VIDEO2 Selection)
BF	COMPONENT1	Discrete IR Code (Input COMPONENT1 Selection)
D4	COMPONENT2	Discrete IR Code (Input COMPONENT2 Selection)
C6	DVI	Discrete IR Code (Input DVI Selection)
D5	RGB	Discrete IR Code (Input RGB Selection)
0E	SLEEP	R/C Button
43	MENU	R/C Button
44	ENTER	R/C Button
4D	APC	R/C Button
52	DASP	R/C Button
60	PIP/DW	R/C Button
61	PIP INPUT	R/C Button
63	SWAP	R/C Button
64	WIN.SIZE	R/C Button
62	POSITION	R/C Button
71	PIP CH+	R/C Button
72	PIP CH-	R/C Button
7B	SPLIT ZOOM	R/C Button
79	ARC	R/C Button
76	ARC (4:3)	Discrete IR Code (Only 4:3 mode)
77	ARC (16:9)	Discrete IR Code (Only 16:9 mode)
AF	ARC (Zoom)	Discrete IR Code (Only Zoom mode)
1E	FCR	R/C Button
1A	REVIEW	R/C Button
54	AUTO PROGRAM	R/C Button
55	MEMORY/ERASE	R/C Button
0A	MTS	R/C Button
39	CAPTION	R/C Button
99	AUTO CONFIG	Discrete IR Code

Programming the Remote

- G The remote control is a multi-brand or universal remote control. It can be programmed to operate most remote-controllable devices of other manufacturers.

Note that the remote control may not control all models of other brands.

Programming a code into a remote mode

1. Test your remote control.
To find out whether your remote control can operate the component without programming, turn on the component such as a VCR and press the corresponding **MODE** button (VCR) on the remote control, while pointing at the component. Test the **POWER** and **CH +/-** buttons to see if the component responds properly. If not, the remote requires programming to operate the device.
2. Turn on the component to be programmed, then press the corresponding **MODE** button on the remote control.
3. Press the **PIP CH-** and **MUTE** buttons simultaneously, the remote control is ready to be programmed for the code.
4. There are two ways to find the right code for the component.
 - A. If you press the **CH +/-** buttons repeatedly, the codes will change one at-a-time. Press the **POWER** button after each code change. If the right code is found, the device will turn off.
 - B. Enter a code number using the number buttons on the remote. Programming code numbers for the corresponding component can be found on the following pages. Again, if the code is correct, the device will turn off.
5. Press the **MENU** button to store the code.
6. Test the remote control functions to see if the component responds properly. If not, repeat from step 2.

Programming Codes

VCRs

Brand	Codes	Brand	Codes	Brand	Codes	Brand	Codes
AIWA	034	KENWOOD	014 034 039 043	PORTLAND	108	TATUNG	039 043
AKAI	016 043 046 124		047 048	PULSAR	072	TEAC	034 039 043
	125 146	LG (GOLDSTAR)	001 012 013 020	QUARTZ	011 014	TECHNICS	031 033 070
AMPRO	072		101 106 114 123	QUASAR	033 066 075 145	TEKNIKA	019 031 033 034
ANAM	031 033 103	LLOYD	034	RCA	013 020 033 034		101
AUDIO DYNAMICS	012 023 039 043	LXI	003 009 013 014		040 041 062 063	THOMAS	034
BROKSONIC	035 037 129		017 034 101 106		107 109 140 144	TMK	006
CANON	028 031 033	MAGIN	040		145 147	TOSHIBA	008 013 042 047
CAPEHART	108	MAGNAVOX	031 033 034 041	REALISTIC	003 008 010 014		059 082 112 131
CRAIG	003 040 135		067 068		031 033 034 040	TOTEVISION	040 101
CURTIS MATHES	031 033 041	MARANTZ	012 031 033 067		053 054 101	UNITECH	040
DAEWOO	005 007 010 064		069	RICO	058	VECTOR RESEARCH	012
	065 108 110 111	MARTA	101	RUNCO	148	VICTOR	048
	112 116 117 119	MATSUI	027 030	SALORA	014	VIDEO CONCEPTS	012 034 046
DAYTRON	108	MEI	031 033	SAMSUNG	032 040 102 104	VIDEOSONIC	040
DBX	012 023 039 043	MEMOREX	003 010 014 031		105 107 109 112	WARDS	003 013 017 024
DYNATECH	034 053		033 034 053 072		113 115 120 122		031 033 034 040
ELECTROHOME	059		101 102 134 139		125		053 054 131
EMERSON	006 017 025 027	MGA	045 046 059	SANSUI	022 043 048 135	YAMAHA	012 034 039 043
	029 031 034 035	MINOLTA	013 020	SANYO	003 007 010 014	ZENITH	034 048 056
	036 037 046 101	MITSUBISHI	013 020 045 046		102 134		058 072 080 101
	129 131 138 153		049 051 059 061	SCOTT	017 037 112 129		
FISHER	003 008 009 010				131		
FUNAI	034	MTC	034 040	SEARS	003 00 009		
GE	031 033 063 072	MULTITECH	024 034	010	013 014 017 020		
	107 109 144 147	NEC	012 023 039 043		031 042 073 081		
GO VIDEO	132 136		048		101		
HARMAN KARDON	012 045	NORDMENDE	043	SHARP	031 054 149		
HITACHI	004 018 026 034	OPTONICA	053 054	SHINTOM	024		
	043 063 137 150	PANASONIC	066 070 074 083	SONY	003 009 031 052		
INSTANTREPLAY	031 033		133 140 145		056 057 058 076		
JCL	031 033	PENTAX	013 020 031 033		077 078 149		
JCPENNY	012 013 015 033		063	SOUNDESIGN	034		
	040 066 101	PHILCO	031 034 067	STS	013		
JENSEN	043	PHILIPS	031 033 034 054	SYLVANIA	031 033 034 059		
JVC	012 031 033 043		067 071 101		067		
	048 050 055 060	PILOT	101	SYMPHONIC	034		
	130 150 152	PIONEER	013 021 048	TANDY	010 034		

CATV

Brand	Codes	Brand	Codes	Brand	Codes	Brand	Codes
ABC	003 004 039 042	GOLDEN CHANNEL	030		065 085 090	SL MARX	030
	046 052 053	HAMLIN	049 050 055	PIONEER	034 051 052 063	SPRUCER	047 078
AJIN	112	HITACHI	052 055		076	STARCOM	002 004 008 009
ANTRONIK	014	HOSPITALITY	070 077	POST NEWS WEEK	016	STARGATE	008 030
ARCHER	005 007 014 024	JERROLD	002 003 004 008	PRUCER	059	SYLVANIA	067
CABLE STAR	026		009 010 052 069	PTS	011 048 071 072	TADIRAN	030
CENTURION	092		074		073 074	TAEKWANG	110
CENTURY	007	LG (GOLDSTAR)	001 106 101 005	PULSAR	100	TAIHAN	105
CITIZEN	007	M-NET	037	RCA	047	TANDY	017
COLOUR VOICE	065 090	MACOM	033	REGAL	049 050	TEXSCAN	029 067
COMBANO	080 081	MAGNAVOX	010 012 064 079	REGENCY	057	TOCOM	039 040 056
COMTRONICS	019 030	MEMOREX	100	REMBRANT	025	TOSHIBA	100
DIAMOND	023	MOVIE TIME	028 032	RK	091	UNIKA	007 014 024
EAGLE	020 030 040	NSC	015 028 038 071	SAMSUNG	102 107 030 068	UNITED CABLE	004 053
EASTERN	057 062 066		073	SCIENTIFIC ATLANTA	003 011 041 042	UNIVERSAL	005 007 014 024
ELECTRICORD	032	OAK	016 031 037 053		043 045 046		026 027 032 035
GE	072	PANASONIC	044 047	SHERITECH	022	VIEWSTAR	012 015 018 086
GEMINI	008 022 025 054	PARAGON	100	SIGNAL	030		087 088 089
GI	052 074	PHILIPS	006 012 013 020	SIGNATURE	052	ZENITH	100 114 060 093

HDSTB

Brand	Codes	Brand	Codes	Brand	Codes	Brand	Codes
ALPHASTAR DSR	123	EUROPLUS	114	MEMOREX	057	STARCAST	041
AMPLICA	050	FUJITSU	017 021 022 027	NEXTWAVE	028 124 125	SUPER GUIDE	020 124 125
BIRDVIEW	051 126 129		133 134	NORSAT	069 070	TEECOM	023 026 075 087
BSR	053	GENERAL INSTRUMENT	003 004 016 029	PACE SKY SATELLITE	143		088 090 107 130
CAPETRONICS	053		031 059 101	PANASONIC	060 142		137
CHANNEL MASTER	013 014 015 018	HITACHI	139 140	PANSAT	121	TOSHIBA	002 127
	036 055	HOUSTON TRACKER	033 037 039 051	PERSONAL CABLE	117	UNIDEN	016 025 042 043
CHAPARRAL	008 009 012 077		057 104	PHILIPS	071		044 045 048 049
CITOH	054	HUGHES	068	PICO	105		078 079 080 086
CURTIS MATHES	050 145	HYTEK	053	PRESIDENT	019 102		101
DRAKE	005 006 007 010	JANIEL	060 147	PRIMESTAR	030 110 111	UNIDEN	135 136
	011 052 112 116	JERROLD	061	PROSAT	072	VIEWSTAR	115
	141	KATHREIN	108	RCA	066 106	WINEGARD	128 146
DX ANTENNA	024 046 056 076	LEGEND	057	REALISTIC	043 074	ZENITH	081 082 083 084
ECHOSTAR	038 040 057 058	LG	001	SAMSUNG	123		091 120
	093 094 095 096	LUTRON	132	SATELLITE SERVICE CO	028 035 047 057		
	097 098 099 100	LUXOR	062 144		085		
	122	MACOM	010 059 063 064	SCIENTIFIC ATLANTA	032 138		
ELECTRO HOME	089		065	SONY	103		

Audio

Brand	Codes	Brand	Codes	Brand	Codes	Brand	Codes
AIWA	014 028 070 096	JVC	004 013 141	PHILIPS	026 112 143 253		147 218
	125 129 139 229	KEC	185 186 187	PIONEER	039 042 043 063	TOSHIBA	137
	230	KENWOOD	038 050 067 089		065 091 093 094	THE	061
AKAI	163		170 171 197 206	QUASAR	115 123 127 250	VICTOR	088 131
ANAM	003 014 017 023	KOHEL	215 222	RCA	113	WARDS	089
	059 106 189 216	NAD	030	RCX	080	YAMAHA	054 055 066 092
	217 235 236	LOTTE	045 046	REALISTIC	092		199
BURMECTER	252		014 016 036 098	SAMSUNG	103 106		
CARVER	086		100 172 173 174		124 145 146 182		
CLARION	199		175 176 177 178		193 194 195 203		
DAEWOO	027 053 060 084		179 180 181 183	SANSUI	204 244 245 246		
	102 148 198 221		201 202 208 213	SANYO	011 135 138 144		
DENON	015 075 130 143		214 219 223 232	SCOTT	019 083 234		
FANTASIA	071		238 240	SHARP	106 186		
FINEARTS	022	LXI	103		031 032 051 052		
FISHER	089 099	MAGNAVOX	111		072 082 117 119		
LG(GOLDSTAR)	001 021 024 029	MARANTZ	002 018 020 025	SHERWOOD	156 184 199 200		
	087 107 108 110		034 041 081 090	SONY	206 209		
	190 191 192 210	MCINTOSH	097 112		005 006 158		
	211 212 239	MCS	049		044 045 109 114		
HAITAI	034 035 188 222	MEMOREX	104	TAEKWANG	118 126 248 249		
HARMAN/KARDON	068	NAD	107		012 020 073 074		
INKEL	037 058 062 069	ONKYO	046		076 077 105 161		
	078 079 095 121		013 040 041 047		162 163 164 165		
	122 149 150 151		048 056 057 132		166 167 168 169		
	152 153 154 155	OPTIMUS	133 140		205 231 233 242		
	157 158 159 160	PANASONIC	158	TEAC	254		
	189 207 222 224		007 033 064 113		010 085 106 136		
	225 226 227 243	PENNEY	142 220 241 251	TECHNICS	185 187 237		
	247		104		101 113 128 134		

DVD

Brand	Codes	Brand	Codes	Brand	Codes	Brand	Codes
APEX DIGITAL	022	MAGNAVOX	013	PHILIPS	013	SONY	007
DENON	020 014	MARANTZ	024	PIONEER	004 026	THOMPSON	005 006
GE	005 006	MITSUBISHI	002	PROCEED	021	TOSHIBA	019 008
HARMAN KARDON	027	NAD	023	PROSCAN	005 006	YAMAHA	009 018
JVC	012	ONKYO	008 017	RCA	005 006	ZENITH	010 016 025
LG	001 010 016 025	PANASONIC	003 009	SAMSUNG	011 015		

Troubleshooting Checklist

<p>No picture & No sound</p>	<ul style="list-style-type: none"> • Check whether the TV is turned on. • Is the power cord inserted into wall power outlet? • Test the wall power outlet, plug another product's power cord into the outlet where the TV's power cord was plugged in.
<p>Picture OK & No sound</p>	<ul style="list-style-type: none"> • Press the VOLUME (G) button. • Sound muted? Press MUTE button.
<p>The remote control doesn't work</p>	<ul style="list-style-type: none"> • Check to see if there is any object between the TV and the remote control causing obstruction. • Are batteries installed with correct polarity (+ to +, - to -)? (Refer to p.9) • Correct remote operating mode set: TV, VCR etc.? • Install new batteries. (Refer to p.9)
<p>Picture appears slowly after switching on</p>	<ul style="list-style-type: none"> • This is normal, the image is muted during the TV startup process. Please contact your service center, if the picture has not appeared after five minutes.
<p>No or poor color or poor picture</p>	<ul style="list-style-type: none"> • Select Color in the Picture menu and press the VOLUME (G) button. (Refer to p.21) • Keep a sufficient distance between the TV and the VCR. • Activate any function to restore the brightness of the picture. (If still picture is on the screen for more than 5 minutes, the screen gets dark.)
<p>Horizontal/vertical bars or picture shaking</p>	<ul style="list-style-type: none"> • Check for local interference such as an electrical appliance or power tool.
<p>No output from one of the speakers</p>	<ul style="list-style-type: none"> • Adjust Balance in the Sound menu. (Refer to p.24)
<p>Unusual sound from inside the TV</p>	<ul style="list-style-type: none"> • A change in ambient humidity or temperature may result in an unusual noise when the plasma display is turned on or off and does not indicate a fault with the TV.

Maintenance

- Early malfunctions can be prevented. Careful and regular cleaning can extend the amount of time you will have your new TV. Be sure to turn the power off and unplug the power cord before you begin any cleaning.

Cleaning the Screen

1. Here's a great way to keep the dust off your screen for a while. Wet a soft cloth in a mixture of lukewarm water and a little fabric softener or dish washing detergent. Wring the cloth until it's almost dry, and then use it to wipe the screen.
2. Make sure the excess water is off the screen, and then let it air-dry before you turn on your TV.

Cleaning the Cabinet

To remove dirt or dust, wipe the cabinet with a soft, dry, lint-free cloth.
Please be sure not to use a wet cloth.

Extended Absence



If you expect to leave your TV dormant for a long time (such as a vacation), it's a good idea to unplug the power cord to protect against possible damage from lightning or power surges.

Product Specifications

MODEL	RU-42PZ61	RU-42PZ71	RU-50PZ61	RU-60PZ61
Width (inches / mm)	49.6 / 1260	49.6 / 1260	57.7 / 1465	56.5 / 1436
Height (inches / mm)	28.5 / 724.8	28.6 / 726.2	33.3 / 845.6	36 / 913.2
Depth (inches / mm)	11.3 / 287	11.3 / 287	13.2 / 335	3.9 / 98.6
Weight (pounds / kg)	96.7 / 43.84	96.7 / 43.84	117.5 / 53.3	172.3 / 78.15
Resolution	1024 x 768 (Dot)	852 x 480 (Dot)	1366 x 768 (Dot)	1366 x 768 (Dot)
Power requirement	AC100-240V, 60Hz			
Television System	NTSC			
Program Coverage	VHF 2 ~ 13, UHF 14 ~ 69, CATV 1 ~ 125			
External Antenna Impedance	75 Ω			
Color	16,770,000 (256 steps of each R, G and B)			
Operating Temperature Range	32 ~ 104°F (0 ~ 40°C)			
Operating Humidity Range	Less than 80%			
Maximum Elevation	6561 feet (2000m)			

Speaker

MODEL	RU-42PZ61	RU-42PZ71	RU-50PZ61
Width (inches / mm)	4.3 / 110		4.7 / 120
Height (inches / mm)	26.4 / 669.3		30.7 / 779.4
Depth (inches / mm)	3.7/95	3.6/90.5	3.9 / 98.2
Weight (pounds / kg)	4.5 / 2.03		5.7 / 2.57

- The specifications shown above may be changed without notice for quality improvement.

Notes



LG ELECTRONICS, INC.
PLASMA TV — U.S. LIMITED WARRANTY

Your LG Plasma TV will be repaired or replaced in accordance with the terms of this warranty, at LGE's option, if it proves to be defective in material or workmanship under normal use, during the warranty period ("Warranty Period") listed below, effective from the date ("Date of Purchase") of original consumer purchase of the product. This warranty is good only to the original purchaser of the product and effective only when used in the United States, including Alaska, Hawaii, and U.S. Territories.

WARRANTY PERIOD:

LABOR and PARTS: 2 YEARS from the Date of Purchase. Your unit will be repaired or replaced with a new, substitute model or factory reconditioned unit, at LGE's option. If repaired, parts used in the repair may be new or remanufactured. Replacement Units and Repair Parts are warranted for the remaining portion of the original unit's warranty period.

EFFECTIVE DATE OF WARRANTY: Your warranty period begins on the date of sale to the original consumer/end user. KEEP THE DEALER'S DATED BILL OF SALE OR PROOF OF DELIVERY as evidence of the purchase date. You will be required to submit a legible copy of your bill of sale or proof of delivery when requesting warranty service.

HOW SERVICE IS HANDLED:

In-Home Service: Please retain dealer's dated bill of sale or delivery ticket as evidence of the Date of Purchase for proof of warranty, and submit a copy of the bill of sale to the service person at the time warranty service is provided.

Please call 1-201-816-2000 to locate your nearest LGE Authorized Service Center.

Visit our website at:
<http://www.lgservice.com>

THIS WARRANTY IS IN LIEU OF ANY OTHER WARRANTY, EXPRESS OR IMPLIED, INCLUDING WITHOUT LIMITATION, ANY WARRANTY OF MERCHANTABILITY OR FITNESS FOR A PARTICULAR PURPOSE. TO THE EXTENT ANY IMPLIED WARRANTY IS REQUIRED BY LAW, IT IS LIMITED IN DURATION TO THE EXPRESS WARRANTY PERIOD ABOVE. NEITHER THE MANUFACTURER NOR ITS U.S. DISTRIBUTOR SHALL BE LIABLE FOR ANY INCIDENTAL, CONSEQUENTIAL, INDIRECT, SPECIAL, OR PUNITIVE DAMAGES OF ANY NATURE, INCLUDING WITHOUT LIMITATION, LOST PROFITS, LOST OR CORRUPTED PROGRAMMING OR DATA, OR ANY OTHER DAMAGE WHETHER BASED IN CONTRACT, TORT, OR OTHERWISE. Some states do not allow the exclusion or limitation of incidental or consequential damages or limitations on how long an implied warranty lasts, so the above exclusion or limitation may not apply to you. This warranty gives you specific legal rights and you may also have other rights that vary from state to state.

CONCERNING PIXEL FUNCTIONALITY: Your Plasma TV contains about one million individual pixels. Plasma TV typically contain a small number of pixels that do not function normally. Your display has been inspected and is in compliance with manufacturer's specifications, indicating that any pixel defects do not effect the operation or use of your display.

IMPORTANT: Please fill out and mail in your Product Registration Card or go to www.lgservice.com to register your product online. This information will allow us to reach you promptly should we discover a safety or reliability problem that could affect you.

THIS LIMITED WARRANTY DOES NOT APPLY TO:

<ul style="list-style-type: none"> ● damage caused in shipping or transit ● service required as a result of improper installation, including incorrect or insufficient AC supply (please consult the owner’s manual for power supply requirements) ● installation or repair of antenna systems, cable converters, cable company supplied equipment, or other components in a video system ● set-up or adjustment on consumer controls, or damage caused by improper adjustments ● damage caused by other system components ● any panel that has been modified or incorporated into any other product ● replacement of batteries on the remote control. ● damage (including cosmetic damage), failure, loss or personal injury due to misuse, abuse, negli- 	<p>gence, improper maintenance or storage, or to acts of nature or other causes beyond our control. (Causes beyond our control include but are not limited to lightning strike, power surges, power outages and water damage.)</p> <ul style="list-style-type: none"> ● image burn-in ● repair or replacement of warranted parts by other than LGE authorized service centers. ● units purchased or serviced outside of the coverage area. ● product where the original factory serial numbers have been removed, defaced or changed in any way. ● product sold and labeled as “as is, where is” or similar disclaimer.
--	--

The cost of repair or replacement under these excluded circumstances shall be borne by the consumer.

CUSTOMER INTERACTIVE CENTER NUMBERS:

<p>To obtain customer assistance, product information or Dealer or Service locations</p>	<p>Call 1-201-816-2000 24 hours a day, 365 days per year</p>
---	---

FOR SERVICE:

Before you call for warranty service, check your operating guide – you may avoid a service call.

For warranty service information, please contact the LGE Customer Interactive Center telephone number.

When calling for service, **please have your product model number, serial number and the date of purchase or the date of original installation available.**

If a replacement unit is required, under some circumstances you may be asked to provide a reserve deposit to the LGE Service Center against a credit card number as surety for advanced shipment. Your credit card will not be charged if you return the defective unit within 10 working days.

If a replacement unit is received, please use the carton and packaging from that unit in returning the defective unit to the LG®Brand Service Center.

Parts and service in accordance with the LGE warranty are LGE’s responsibility and will be provided without charge. Other service requirements will be at the owner’s expense. If you have problems in obtaining satisfactory warranty service, write or call the LGE Customer Interactive Center. Service may be provided by independently owned and operated service organizations.

To assure proper credit and avoid unnecessary charges, you must obtain an LGE Return Authorization before returning any product to the LGE Service Center. Contact the Customer Interactive Center for details.

TO CONTACT THE LGE CUSTOMER SERVICE CENTER BY MAIL:

LGE Customer Interactive Center
P.O. Box 240007
201 James Record Road
Huntsville, Alabama 35824
<http://www.lgservice.com>

P/N : 3828VA0470Q